

Features

- Low saturation voltage
- As Complementary Type of the PNP Transistor 2SAR553SQ is Recommended

Equivalent Circuit

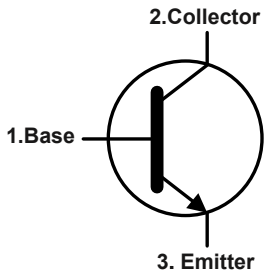

SOT-89

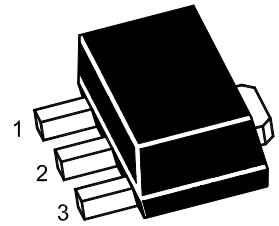

1.Base 2.Collector 3. Emitter

Marking Code : EL

Absolute Maximum Ratings

Ratings at 25°C ambient temperature unless otherwise specified.

Parameter	Symbol	Value	Unit
Collector Base Voltage	V_{CBO}	50	V
Collector Emitter Voltage	V_{CEO}	50	V
Emitter Base Voltage	V_{EBO}	6	V
Collector Current	I_C	2	A
Maximum Power Dissipation	P_D	500	mW
Junction Temperature	T_J	150	°C
Storage Temperature Range	T_{STG}	-55 to +150	°C



Electrical Characteristics (T_A=25°C)

Parameter	Symbol	Min.	Typ.	Max.	Unit
DC Current Gain at V _{CE} = 2 V, I _C = 50 mA	H _{FE}	180	--	450	--
Collector Base Cutoff Current at V _{CB} = 50 V	I _{CBO}	--	--	0.1	μA
Emitter Base Cutoff Current at V _{EB} = 4 V	I _{EBO}	--	--	0.1	μA
Collector Base Breakdown Voltage at I _C = 100 μA	V _{(BR)CBO}	50	--	--	V
Collector Emitter Breakdown Voltage at I _C = 1 mA	V _{(BR)CEO}	50	--	--	V
Emitter Base Breakdown Voltage at I _E = 100 μA	V _{(BR)EBO}	6	--	--	V
Collector Emitter Saturation Voltage at I _C = 700 mA, I _B = 35 mA	V _{CE(sat)}	--	--	0.35	V
Base Emitter Saturation Voltage at I _C = 500 mA, I _B = 50 mA	V _{BE(sat)}	--	--	1.2	V
Transition Frequency at V _{CE} = 10 V, I _E = 300 mA, f=100MHz	F _T	--	360	--	MHz



Typical Characteristics Curves

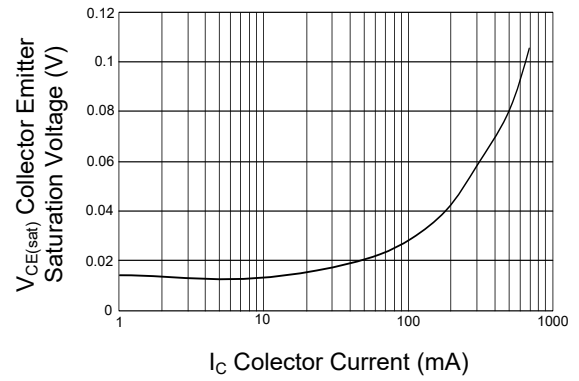
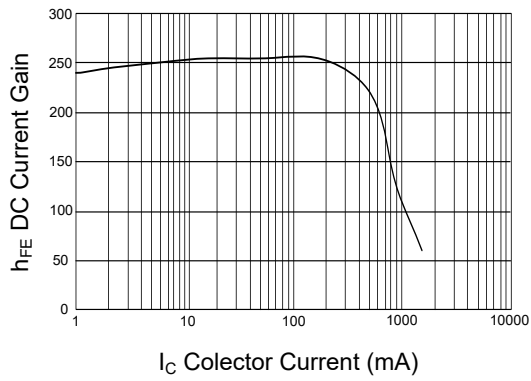

Package Outline

SOT-89

Dimensions in mm



Ordering Information

Device	Package	Shipping
2SCR553SQ	SOT-89	1,000PCS/Reel&7inches
		3,000PCS/Reel&13inches

Conditions of Soldering and Storage

◆ Recommended condition of reflow soldering



Recommended peak temperature is over 245 °C. If peak temperature is below 245 °C, you may adjust the following parameters:

- Time length of peak temperature (longer)
- Time length of soldering (longer)
- Thickness of solder paste (thicker)

◆ Conditions of hand soldering

- Temperature: 370 °C
- Time: 3s max.
- Times: one time

◆ Storage conditions

- **Temperature**
5 to 40 °C
- **Humidity**
30 to 80% RH
- **Recommended period**
One year after manufacturing

Package Specifications

- The method of packaging (1,000PCS/Reel&7inches)

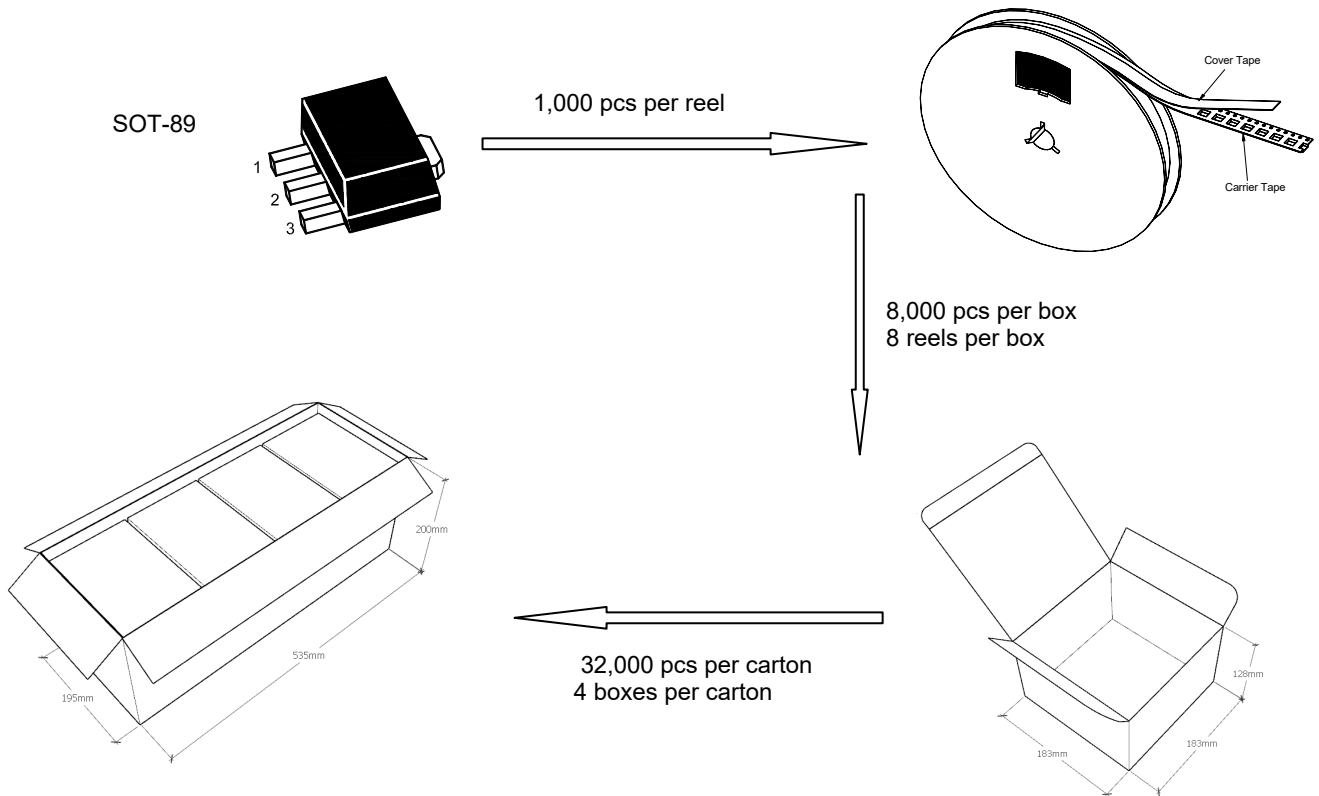

◆ Embossed tape and reel data

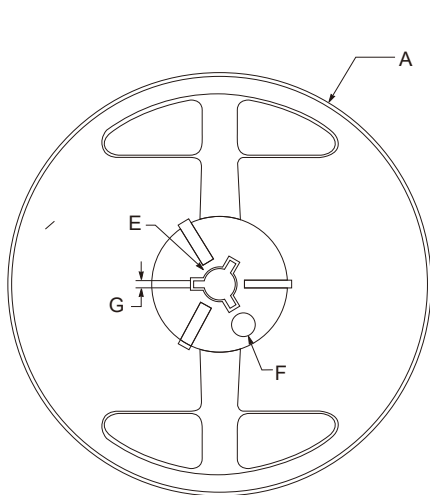

Reel (7")

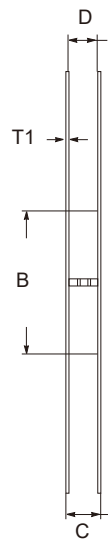

symbol	Value(unit:mm)
A	$\Phi 179 \pm 1$
B	60.5 ± 0.2
C	15.3 ± 0.3
D	$12.5 \sim 13.7$
E	$\Phi 13.5 \pm 0.2$
F	$\Phi 10.0 \pm 0.2$
G	2.7 ± 0.2
T1	1.0 ± 0.2

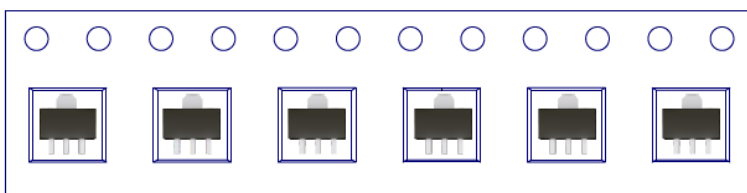

Package Specifications

- The method of packaging (3,000PCS/Reel&13inches)

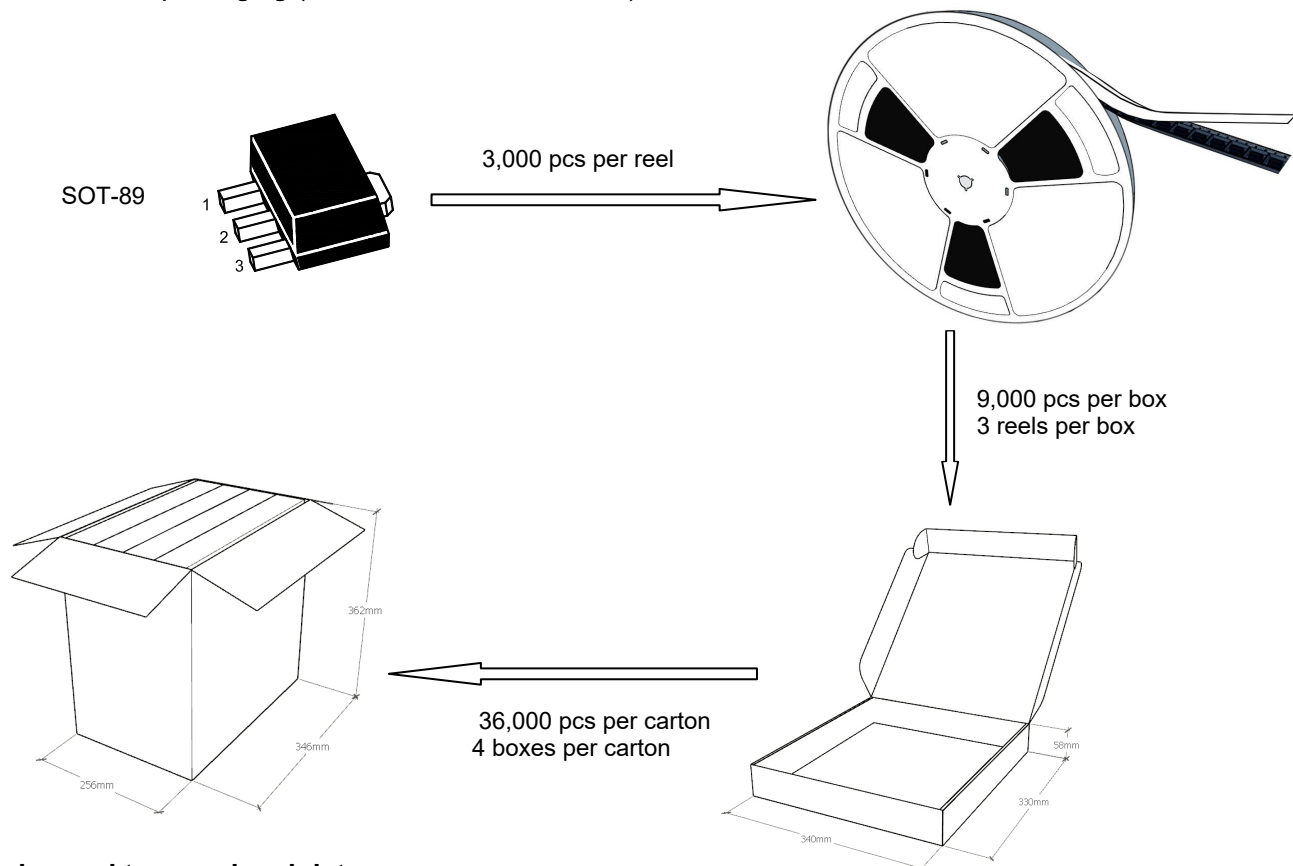

◆ Embossed tape and reel data



symbol	Value(unit:mm)
A	$\Phi 330 \pm 1$
B	12.7 ± 0.5
C	16.5 ± 0.3
D	$\Phi 99.5 \pm 0.5$
E	$\Phi 13.6 \pm 0.3$
F	2.8 ± 0.3
T1	1.9 ± 0.2

