



M1-PJ~M7-PJ

Surface Mount General Purpose Silicon Rectifiers

Features

- For surface mount applications
- Glass passivated chip junction
- Low profile package
- Easy to pick and place

SMAF

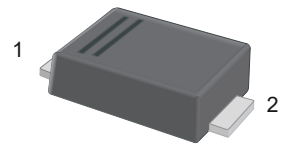

1.Cathode  2.Anode

Marking Code:

M1-PJ: M1
M2-PJ: M2
M3-PJ: M3
M4-PJ: M4
M5-PJ: M5
M6-PJ: M6
M7-PJ: M7

Maximum Ratings and Electrical Characteristics

Ratings at 25°C ambient temperature unless otherwise specified. Single phase half-wave 60 Hz, resistive or inductive load, for capacitive load current derate by 20 %.

Parameter	Symbols	M1-PJ	M2-PJ	M3-PJ	M4-PJ	M5-PJ	M6-PJ	M7-PJ	Units
Maximum Repetitive Peak Reverse Voltage	V_{RRM}	50	100	200	400	600	800	1000	V
Maximum RMS Voltage	V_{RMS}	35	70	140	280	420	560	700	V
Maximum DC Blocking Voltage	V_{DC}	50	100	200	400	600	800	1000	V
Maximum Average Forward Rectified Current at $T_C = 125^\circ\text{C}$	$I_{F(AV)}$	1.0							A
Peak Forward Surge Current 8.3 ms Single Half Sine Wave Superimposed on Rated Load	I_{FSM}	30							A
Maximum Instantaneous Forward Voltage at 1 A	V_F	1.1							V
Maximum DC Reverse Current at Rated DC Blocking Voltage $T_A = 25^\circ\text{C}$ $T_A = 125^\circ\text{C}$	I_R	5 50							μA
Typical Junction Capacitance ^{Note1}	C_j	15							pF
Typical Thermal Resistance ^{Note2}	$R_{\theta JA}$	80							$^\circ\text{C/W}$
Junction Temperature	T_J	150							$^\circ\text{C}$
Storage Temperature Range	T_{STG}	-55 to +150							$^\circ\text{C}$

Note:

1. Measured at 1 MHz and applied reverse voltage of 4 V DC.
2. P.C.B. mounted with 2.0" X 2.0" (5 X 5 cm) copper pad areas.



M1-PJ~M7-PJ

Surface Mount General Purpose Silicon Rectifiers

Typical Characteristic Curves

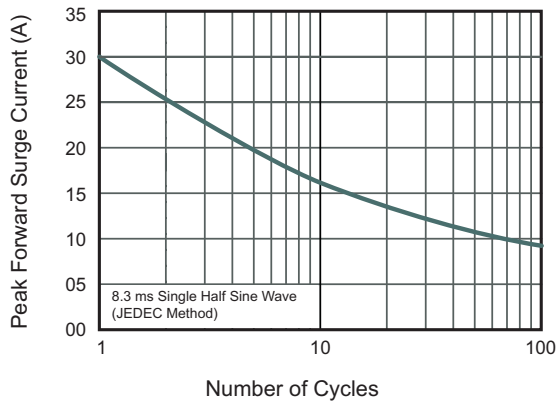
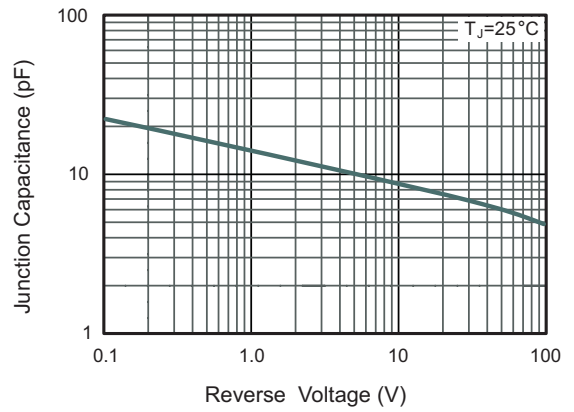
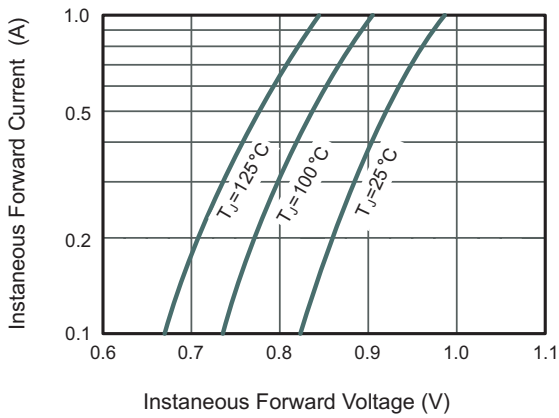
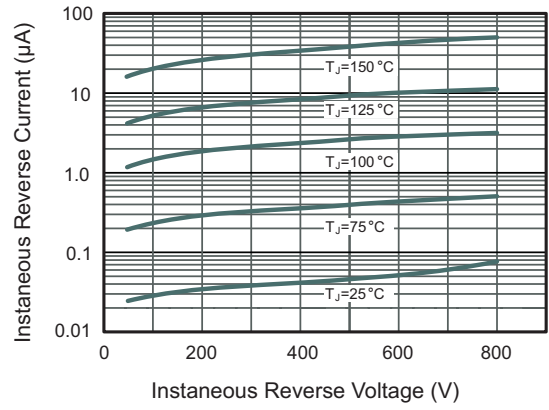
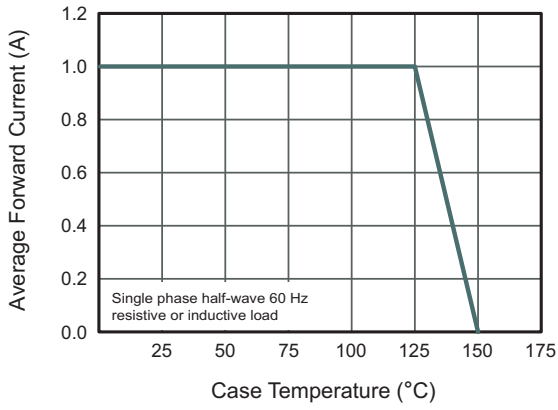



M1-PJ~M7-PJ

Surface Mount General Purpose Silicon Rectifiers

Package Outline

SMAF

Dimensions in mm

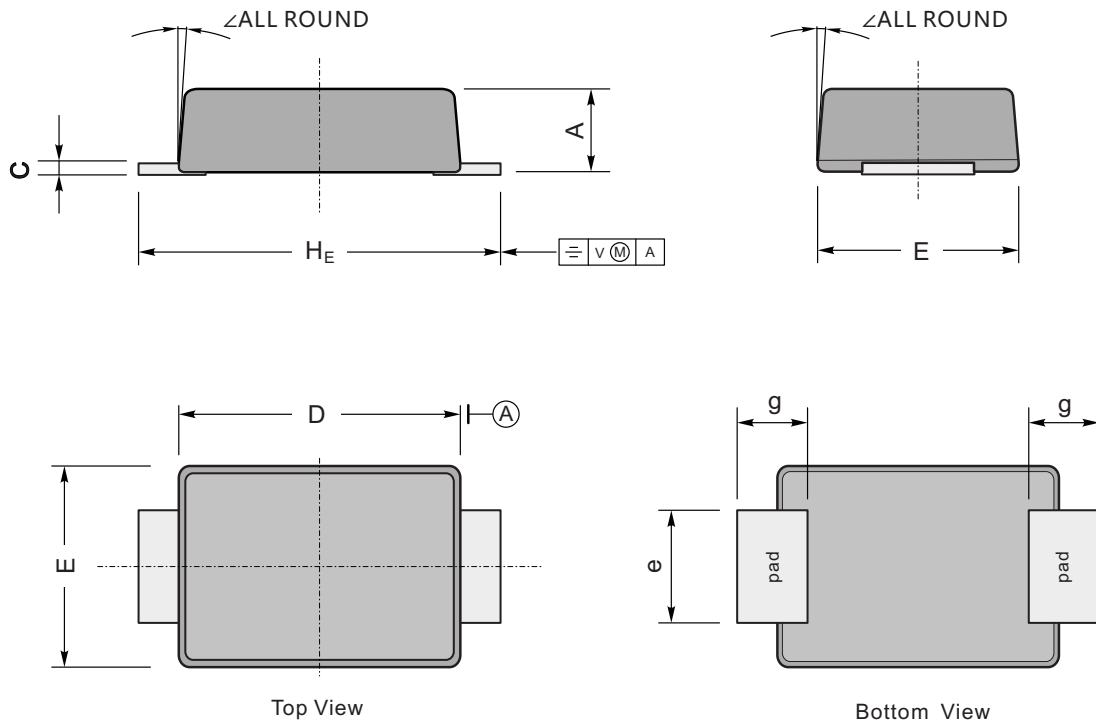

UNIT		A	C	D	E	e	g	H_E	\angle
mm	max	1.2	0.20	3.7	2.7	1.6	1.2	4.9	7°
	min	0.9	0.12	3.3	2.4	1.3	0.8	4.4	
mil	max	47	7.9	146	106	63	47	193	
	min	35	4.7	130	94	51	31	173	