



MMBD4148 Silicon Epitaxial Planar Switching Diode

Features

- High voltage
- Small package
- Small capacitance

SOT-23

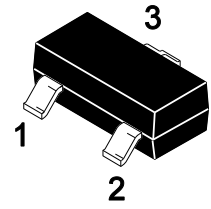

Equivalent Circuit

MMBD4148

3.Cathode

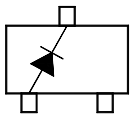

1.Anode 2.NC

MMBD4148SE

3.Cathode1、 Anode2

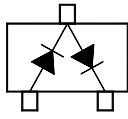

1.Anode1 2.Cathode2

MMBD4148CC

3.Cathode1、 Cathode2

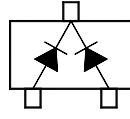

1.Anode1 2.Anode2

MMBD4148CA

3.Anode1、 Anode2

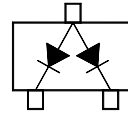

1.Cathode1 2.Cathode2

Marking Code :

MMBD4148 : 5D

MMBD4148SE : A7

MMBD4148CC : A3

MMBD4148CA : A1

Absolute Maximum Ratings ($T_A=25^\circ\text{C}$)

Parameter	Symbol	Value	Unit
Maximum Repetitive Reverse Voltage	V_{RRM}	100	V
Reverse Voltage	V_R	75	V
Average Rectified Forward Current	$I_{F(AV)}$	200	mA
DC Forward Current	I_{FM}	600	mA
Repetitive Peak Forward Current	I_{FRM}	700	mA
Non-repetitive Peak Forward Surge Current	I_{FSM}	1 4	A
		at $t = 1 \text{ s}$ at $t = 1 \mu\text{s}$	
Power Dissipation	P_D	350	mW
Junction Temperature	T_J	150	$^\circ\text{C}$
Storage Temperature Range	T_{STG}	-55 to +150	$^\circ\text{C}$



MMBD4148

Silicon Epitaxial Planar Switching Diode

Electrical Characteristics ($T_A=25^\circ\text{C}$)

Parameter	Symbol	Min.	Max.	Unit
Forward Voltage at $I_F = 10\text{ mA}$	V_F	--	0.85	V
Reverse Breakdown Voltage at $I_R = 100\ \mu\text{A}$ at $I_R = 5\ \mu\text{A}$	$V_{(BR)R}$	100 75	-- --	V
Reverse Current at $V_R = 20\text{ V}$ at $V_R = 75\text{ V}$ at $V_R = 20\text{ V}$, at $T_A = 150^\circ\text{C}$	I_R	-- -- --	25 1 50	nA μA μA
Typical Junction Capacitance at $V_R = 0\text{ V}$, $f = 1\text{ MHz}$	C_j	--	4	pF
Maximum Reverse Recovery Time at $I_F = 10\text{ mA}$, $V_R = 6\text{ V}$, $I_{RR} = 1\text{ mA}$, $R_L = 100\ \Omega$	T_{rr}	--	4	nS



MMBD4148

Silicon Epitaxial Planar Switching Diode

Typical Characteristic Curves

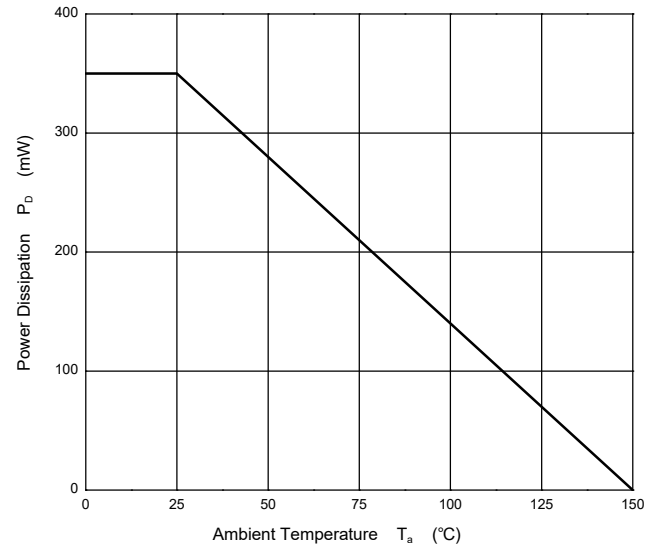
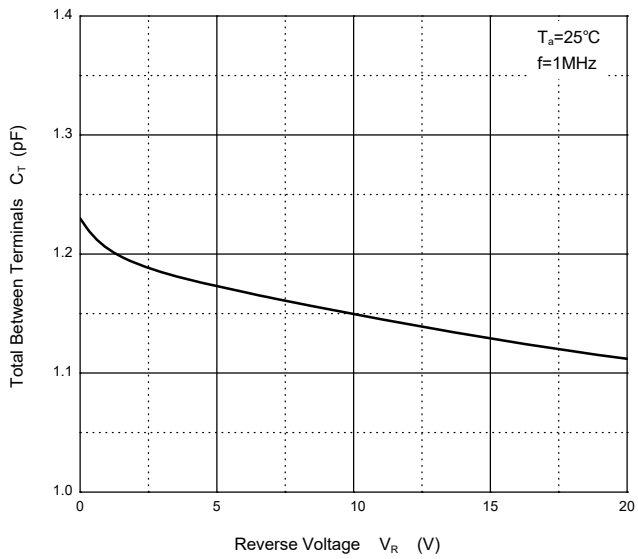
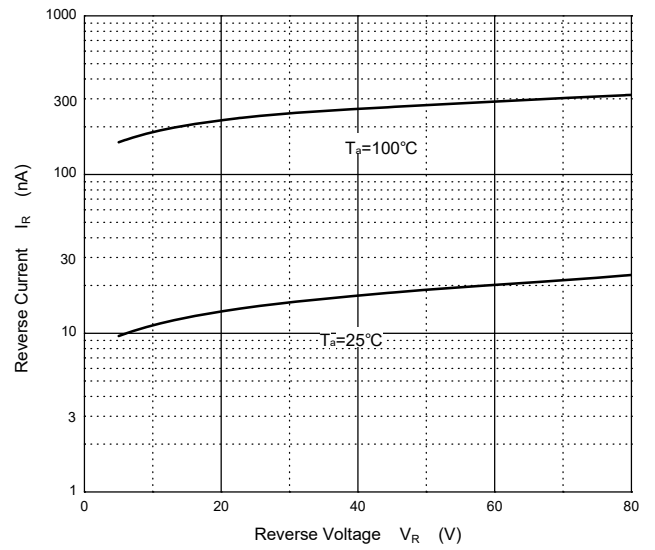
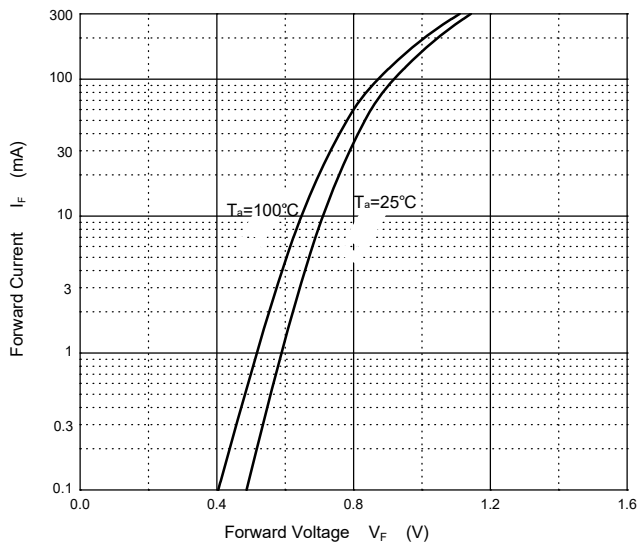



MMBD4148

Silicon Epitaxial Planar Switching Diode

Package Outline

SOT-23

Dimensions in mm

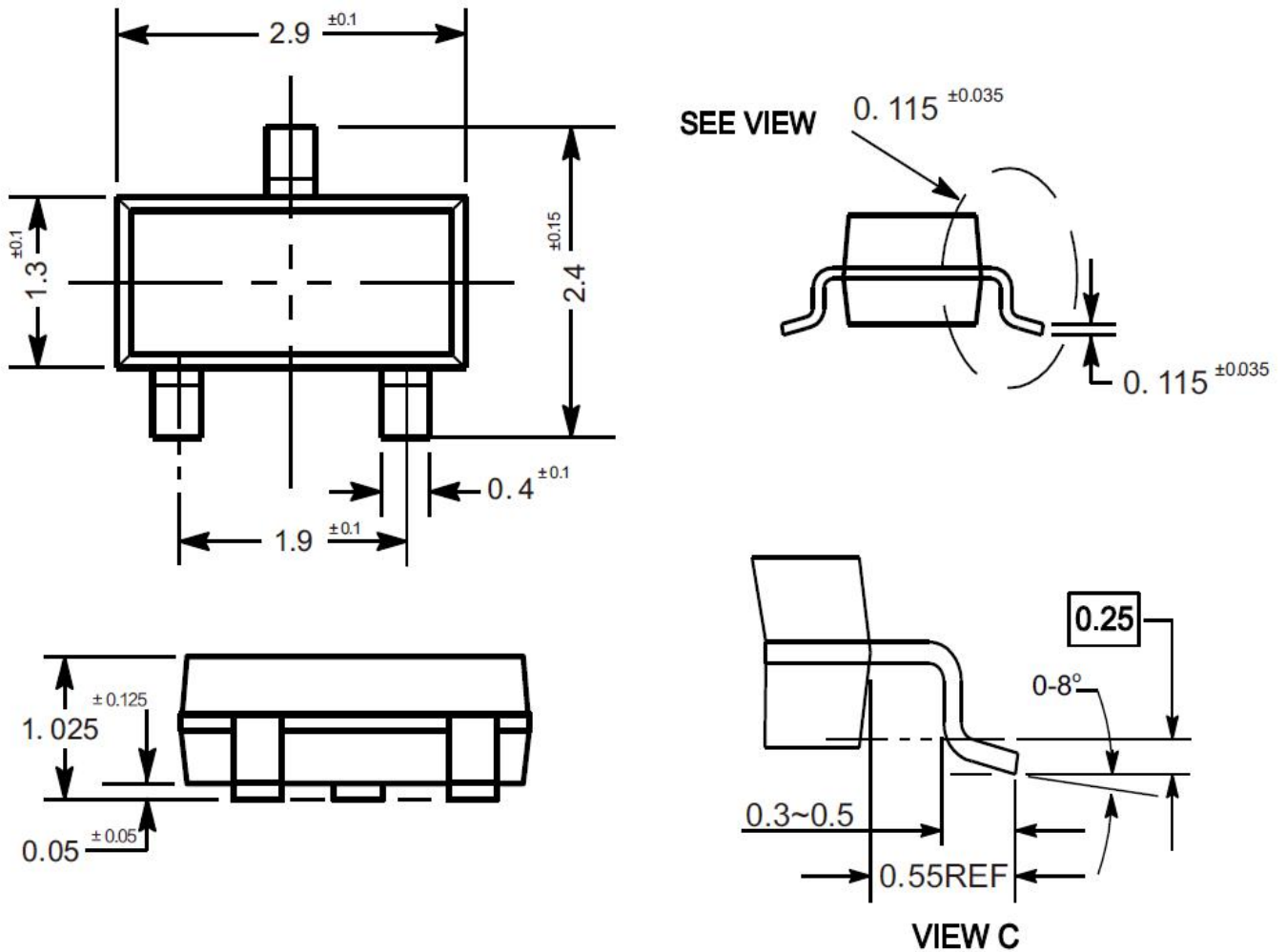

Ordering Information

Device	Package	Shipping
MMBD4148	SOT-23	3,000PCS/Reel&7inches