



PJM08C40PA

N and P-Channel Complementary Power MOSFET

Product Summary

- **N-Channel**
- $V_{DS} = 40V, I_D = 8A$
- $R_{DS(on)} < 19m\Omega @ V_{GS} = 10V$
- $R_{DS(on)} < 29m\Omega @ V_{GS} = 4.5V$
- **P-Channel**
- $V_{DS} = -40V, I_D = -7A$
- $R_{DS(on)} < 35m\Omega @ V_{GS} = -10V$
- $R_{DS(on)} < 45m\Omega @ V_{GS} = -4.5V$

Features

- Advanced Trench Technology
- 100% Avalanche Tested
- RoHS and Reach Compliant
- Halogen and Antimony Free
- Moisture Sensitivity Level 3

Application

- Power Management

Marking Code

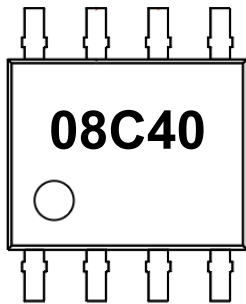

SOP-8

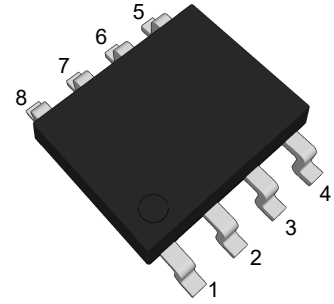

(Top View)

Pin	Description	Pin	Description
1	Source1	4	Gate2
2	Gate1	5,6	Drain2
3	Source2	7,8	Drain1

Schematic Diagram

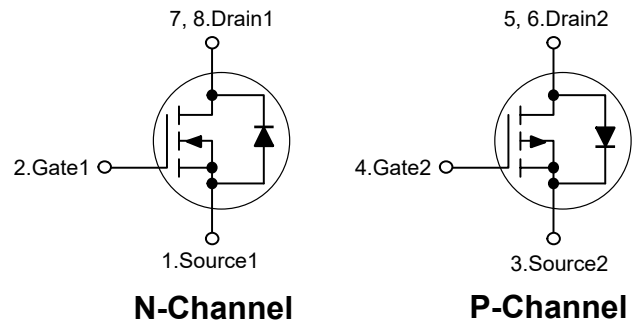



PJM08C40PA

N and P-Channel Complementary Power MOSFET

Absolute Maximum Ratings

Ratings at 25°C ambient temperature unless otherwise specified.

Parameter	Symbol	N-Channel	P-Channel	Unit
Drain-Source Voltage	V_{DS}	40	-40	V
Gate-Source Voltage	V_{GS}	±20		V
Drain Current-Continuous	I_D	8	-7	A
Drain Current-Pulsed ^{Note1}	I_{DM}	40	-30	A
Maximum Power Dissipation	P_D	2		W
Junction Temperature	T_J	150		°C
Storage Temperature Range	T_{STG}	-55 to +150		°C

Thermal Characteristics

Thermal Resistance, Junction-to-Ambient ^{Note2}	$R_{\theta JA}$	62.5	62.5	°C/W
--	-----------------	------	------	------

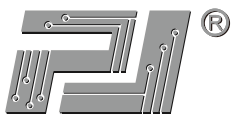
**N-Channel****Electrical Characteristics**(T_a=25°C unless otherwise specified)

Parameter	Symbol	Test Condition	Min.	Typ.	Max.	Unit
Static Characteristics						
Drain-Source Breakdown Voltage	V _{(BR)DSS}	V _{GS} =0V, I _D =250μA	40	--	--	V
Zero Gate Voltage Drain Current	I _{DSS}	V _{DS} =40V, V _{GS} =0V	--	--	1	μA
Gate-Body Leakage Current	I _{GSS}	V _{GS} =±20V, V _{DS} =0V	--	--	±100	nA
Gate Threshold Voltage ^{Note3}	V _{GS(th)}	V _{DS} =V _{GS} , I _D =250μA	1	1.5	2	V
Drain-Source On-Resistance ^{Note3}	R _{DS(on)}	V _{GS} =10V, I _D =8A	--	14	19	mΩ
		V _{GS} =4.5V, I _D =4A	--	19	29	mΩ
Forward Transconductance ^{Note3}	g _{FS}	V _{DS} =5V, I _D =8A	33	--	--	S
Dynamic Characteristics						
Input Capacitance	C _{iss}	V _{DS} =20V, V _{GS} =0V, f=1MHz	--	415	--	pF
Output Capacitance	C _{oss}		--	112	--	pF
Reverse Transfer Capacitance	C _{rss}		--	11	--	pF
Total Gate Charge	Q _g	V _{DS} =20V, I _D =8A, V _{GS} =10V	--	12	--	nC
Gate-Source Charge	Q _{gs}		--	3.2	--	nC
Gate-Drain Charge	Q _{gd}		--	3.1	--	nC
Switching Characteristics						
Turn-on Delay Time	t _{d(on)}	V _{DD} =15V, R _L =2.5Ω V _{GS} =10V, R _{GEN} =3Ω	--	4	--	nS
Turn-on Rise Time	t _r		--	3	--	nS
Turn-off Delay Time	t _{d(off)}		--	15	--	nS
Turn-off Fall Time	t _f		--	2	--	nS
Source-Drain Diode Characteristics						
Diode Forward Voltage ^{Note3}	V _{SD}	V _{GS} =0V, I _S =8A	--	0.8	1.2	V
Diode Forward Current ^{Note2}	I _S		--	--	8	A

Note: 1. Repetitive Rating: Pulse width limited by maximum junction temperature.

2. Surface Mounted on FR4 Board, t ≤ 10 sec.

3. Pulse Test: Pulse width ≤ 300μs, duty cycle ≤ 2%

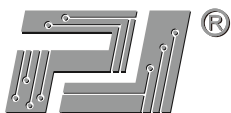
**P-Channel****Electrical Characteristics**(T_a=25°C unless otherwise specified)

Parameter	Symbol	Test Condition	Min.	Typ.	Max.	Unit
Static Characteristics						
Drain-Source Breakdown Voltage	-V _{(BR)DSS}	V _{GS} =0V, I _D =-250μA	40	--	--	V
Zero Gate Voltage Drain Current	-I _{DSS}	V _{DS} =-40V, V _{GS} =0V	--	--	1	μA
Gate-Body Leakage Current	I _{GSS}	V _{GS} =±20V, V _{DS} =0V	--	--	±100	nA
Gate Threshold Voltage ^{Note3}	-V _{GS(th)}	V _{DS} =V _{GS} , I _D =-250μA	1	1.5	2	V
Drain-Source On-Resistance ^{Note3}	R _{DS(on)}	V _{GS} =-10V, I _D =-8A	--	29	35	mΩ
		V _{GS} =-4.5V, I _D =-4A	--	34	45	mΩ
Forward Transconductance ^{Note3}	g _{FS}	V _{DS} =-5V, I _D =-8A	10	--	--	S
Dynamic Characteristics						
Input Capacitance	C _{iss}	V _{DS} =-20V, V _{GS} =0V, f=1MHz	--	520	--	pF
Output Capacitance	C _{oss}		--	100	--	pF
Reverse Transfer Capacitance	C _{rss}		--	65	--	pF
Total Gate Charge	Q _g	V _{DS} =-20V, I _D =-8A, V _{GS} =-10V	--	13	--	nC
Gate-Source Charge	Q _{gs}		--	3.8	--	nC
Gate-Drain Charge	Q _{gd}		--	3.1	--	nC
Switching Characteristics						
Turn-on Delay Time	t _{d(on)}	V _{DD} =-20V, R _L =2.3Ω V _{GS} =-10V, R _{GEN} =6Ω	--	7.5	--	nS
Turn-on Rise Time	t _r		--	5.5	--	nS
Turn-off Delay Time	t _{d(off)}		--	19	--	nS
Turn-off Fall Time	t _f		--	7	--	nS
Source-Drain Diode Characteristics						
Diode Forward Voltage ^{Note3}	-V _{SD}	V _{GS} =0V, I _S =-7A	--	--	1.2	V
Diode Forward Current ^{Note2}	-I _S		--	--	7	A

Note: 1. Repetitive Rating: Pulse width limited by maximum junction temperature.

2. Surface Mounted on FR4 Board, t ≤ 10 sec.

3. Pulse Test: Pulse width ≤ 300μs, duty cycle ≤ 2%



N-Channel

Typical Characteristics Curves

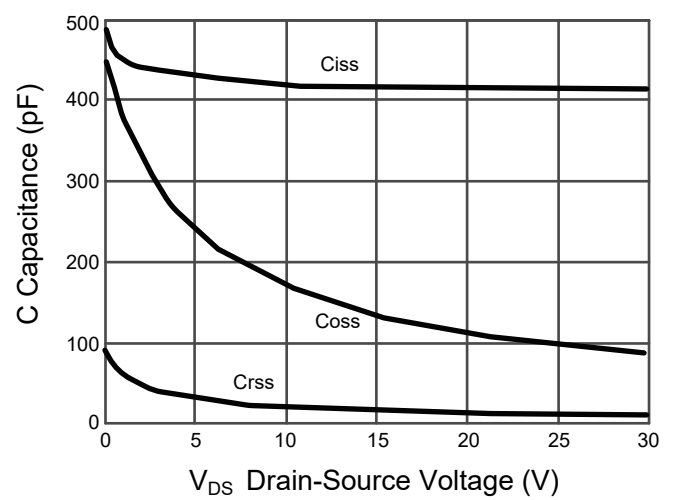
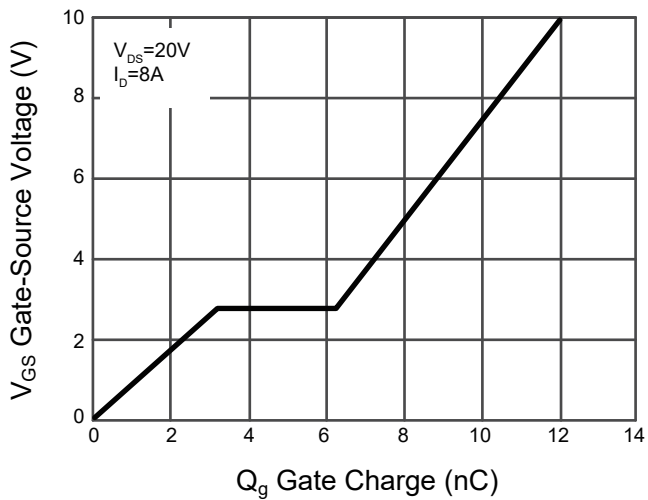
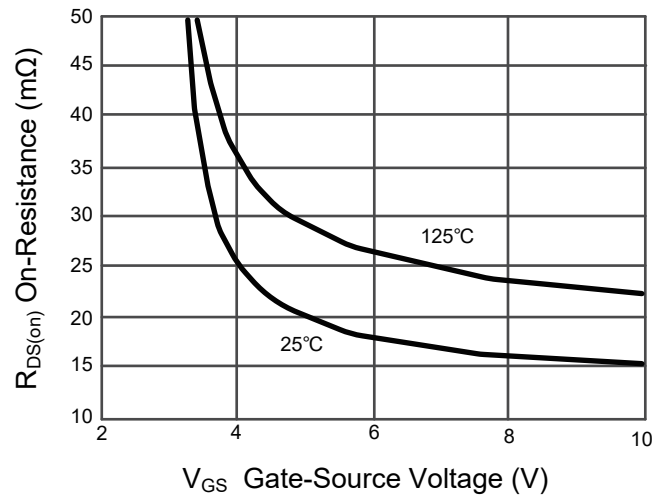
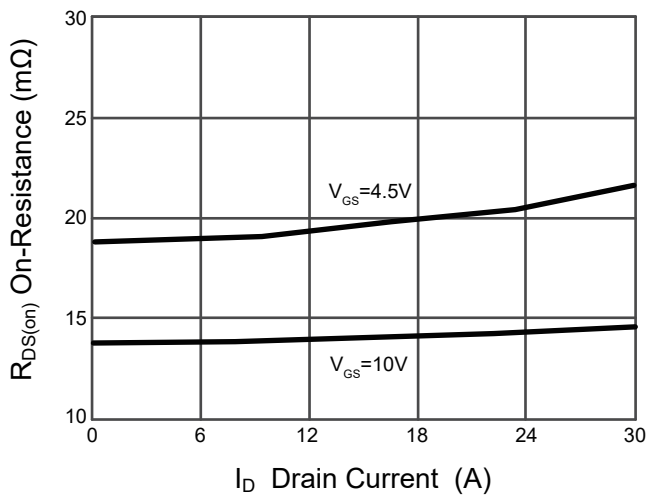
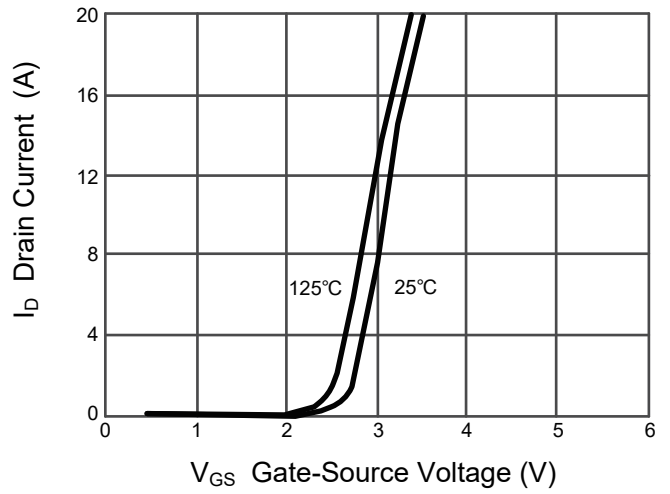
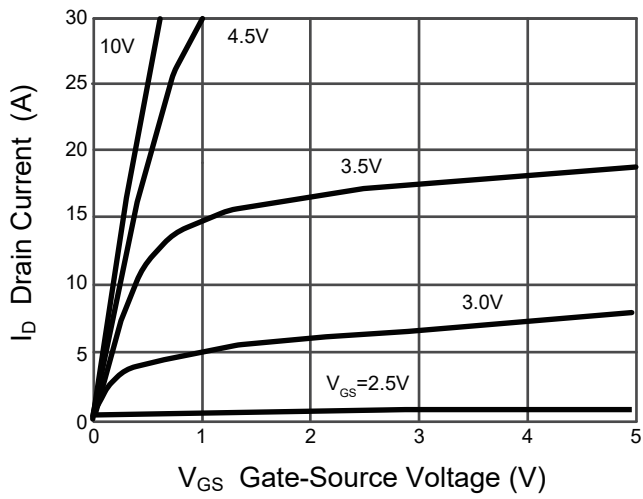



PJM08C40PA

N and P-Channel Complementary Power MOSFET

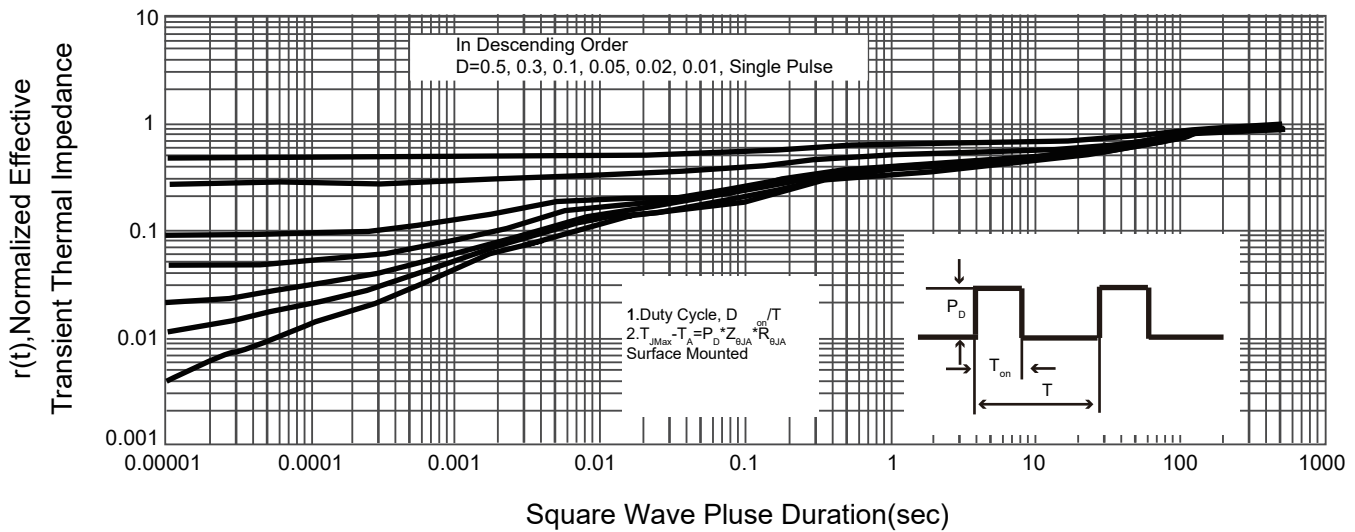
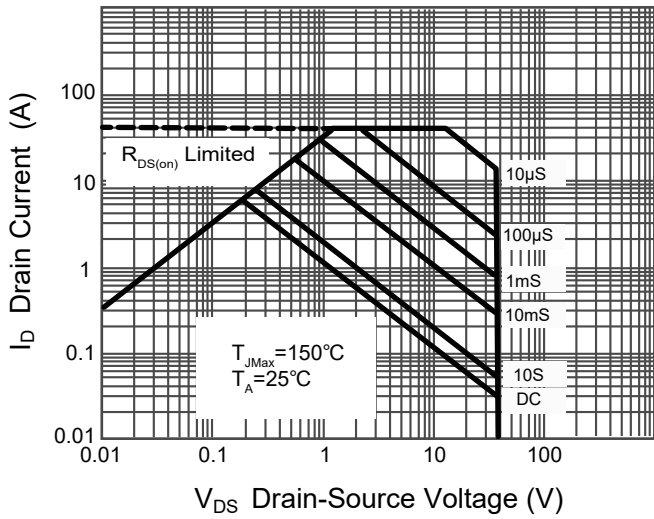
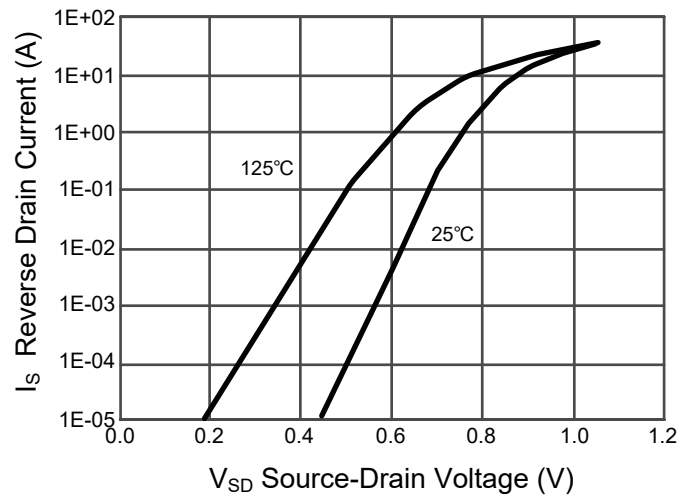
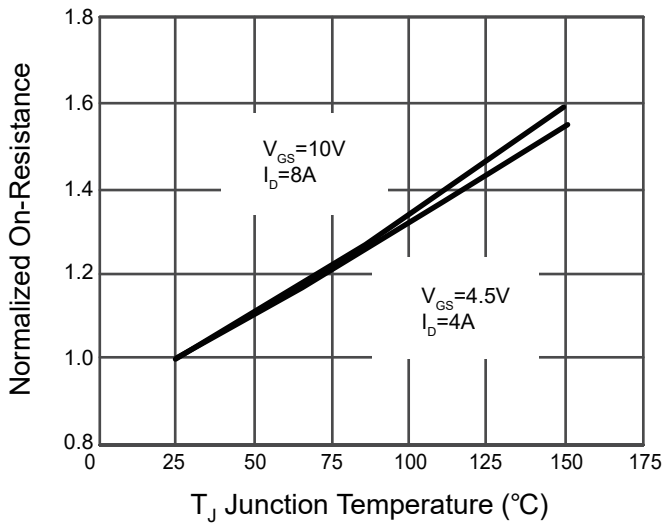



PJM08C40PA

N and P-Channel Complementary Power MOSFET

P-Channel

Typical Characteristics Curves

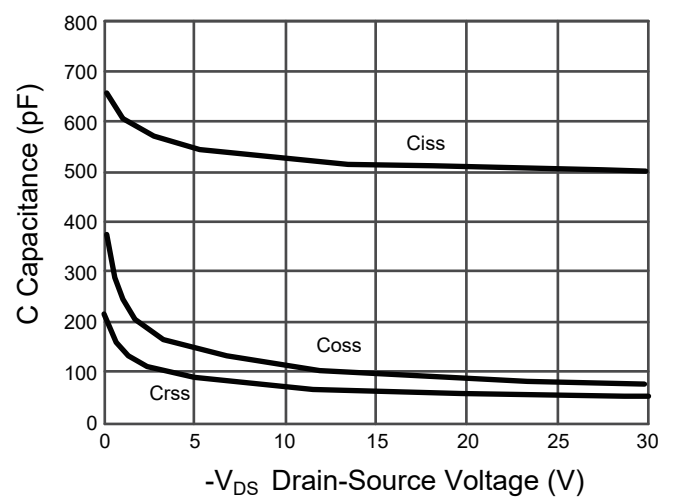
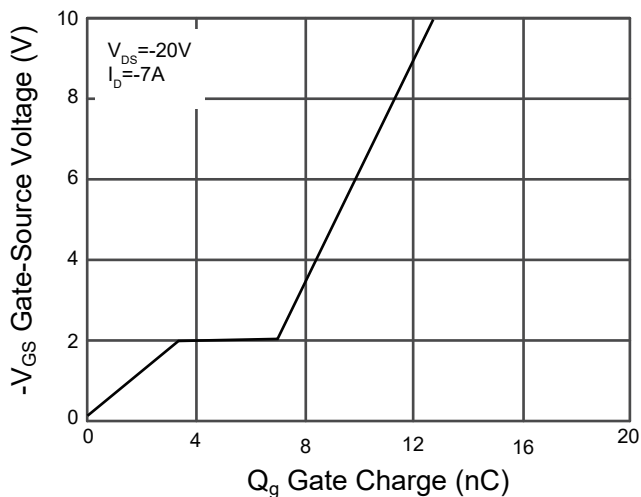
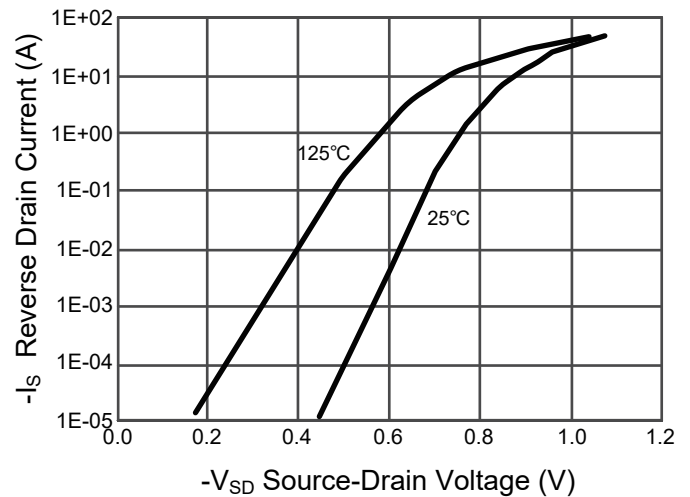
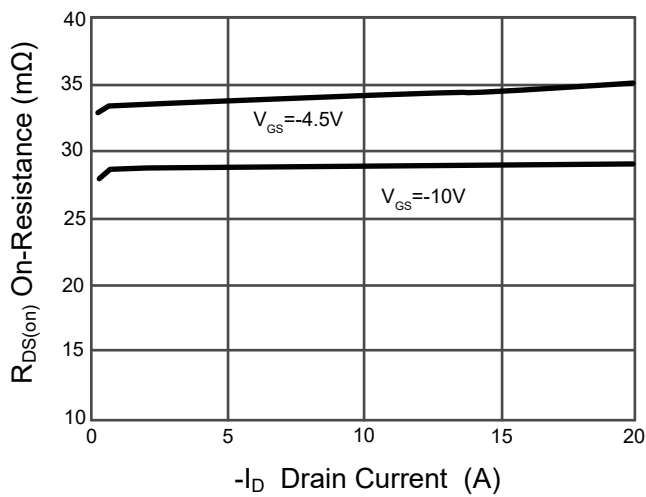
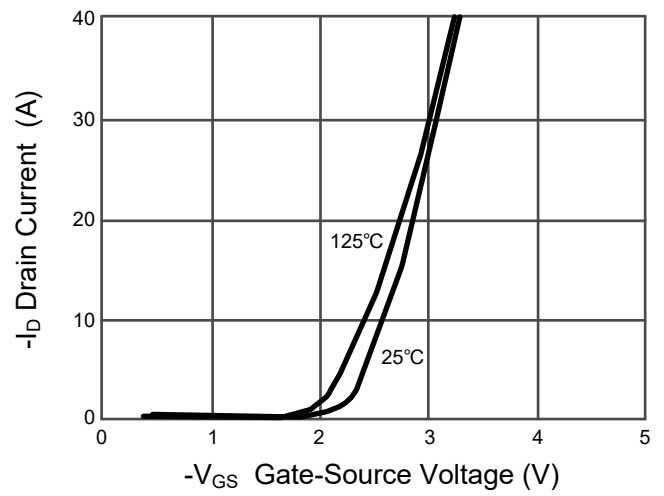
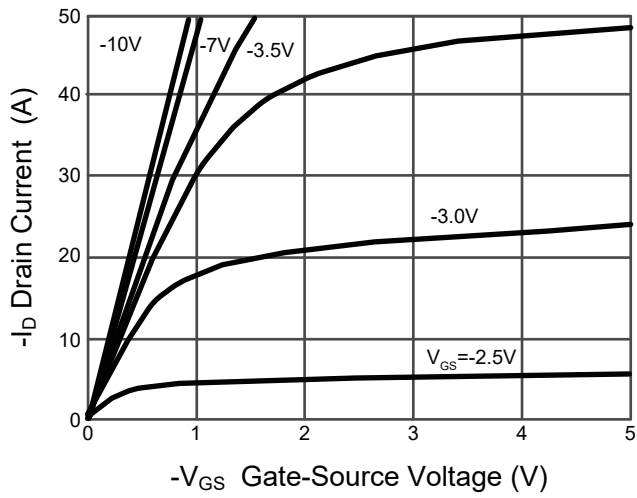



PJM08C40PA

N and P-Channel Complementary Power MOSFET

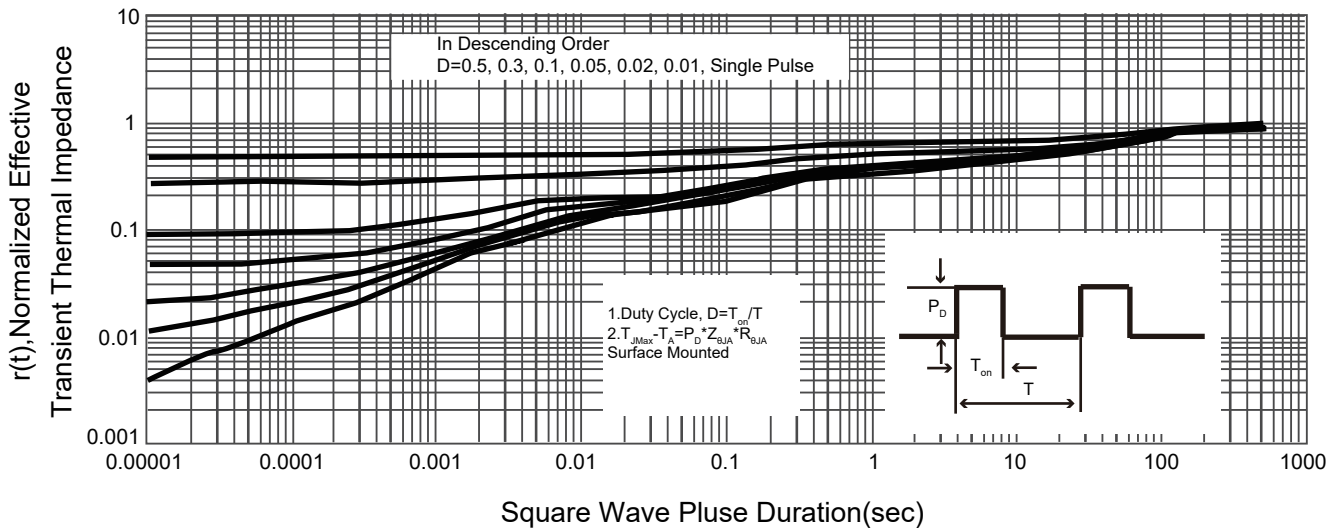
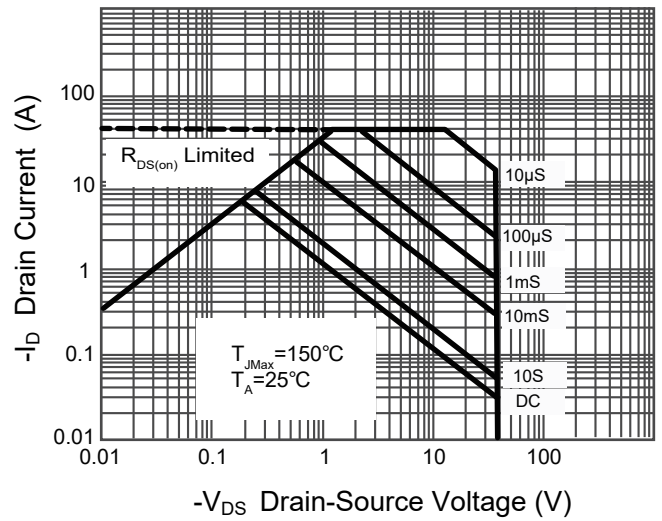
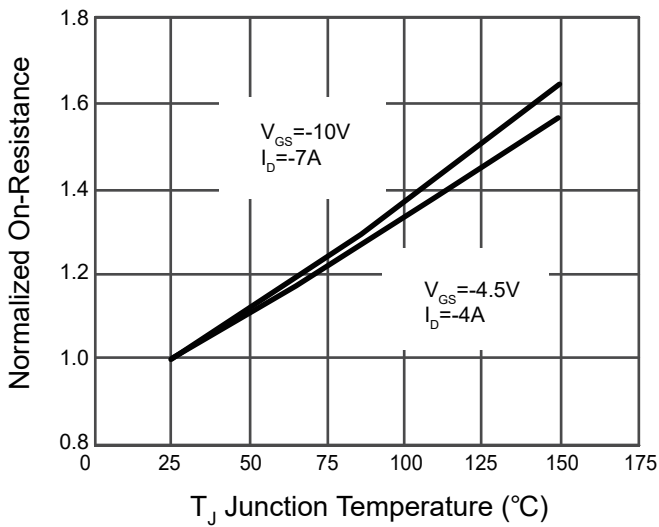



PJM08C40PA

N and P-Channel Complementary Power MOSFET

Package Outline

SOP-8

Dimensions in mm

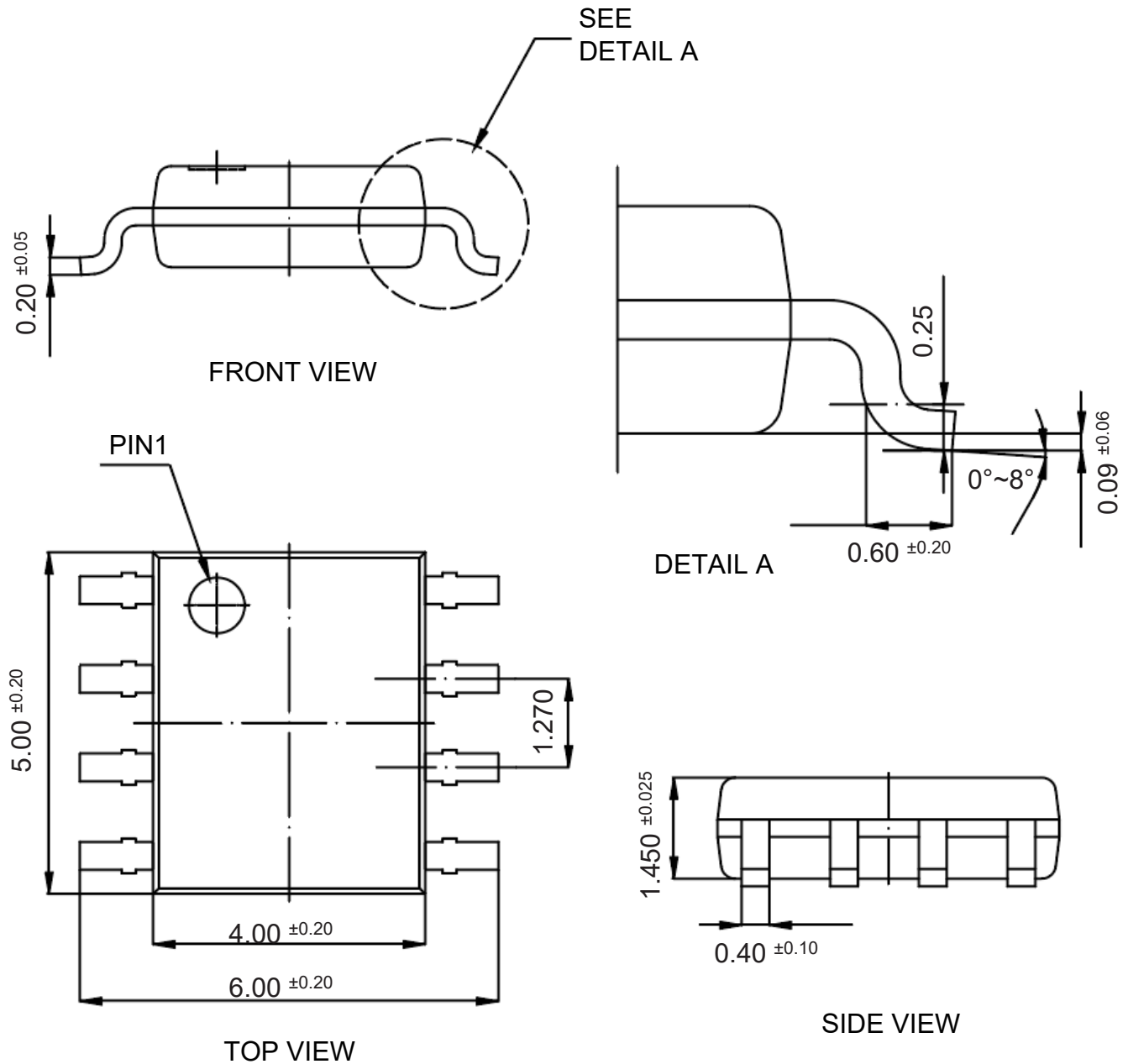

Ordering Information

Device	Package	Shipping
PJM08C40PA	SOP-8	4,000PCS/Reel&13inches