



# PJM40P30TE

## P-Channel Enhancement Mode Power MOSFET

### Product Summary

- $V_{DS} = -30V, I_D = -40A$
- $R_{DS(on)} < 9.5m\Omega @ V_{GS} = -10V$
- $R_{DS(on)} < 18m\Omega @ V_{GS} = -4.5V$

### Features

- Advanced Trench Technology
- 100% Avalanche Tested
- RoHS Compliant
- Halogen and Antimony Free
- Moisture Sensitivity Level 3

### Application

- Load Switch
- Battery Protection
- Power Management

### Marking Code

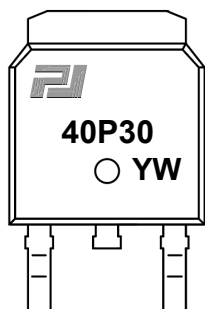

### TO-252

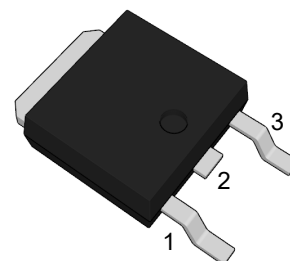

(Top View)

Pin	Description
1	Gate
2	Drain
3	Source

### Schematic Diagram

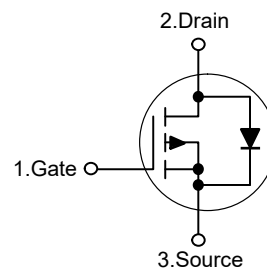

### Absolute Maximum Ratings

Ratings at 25°C case temperature unless otherwise specified.

Parameter	Symbol	Value	Unit
Drain-Source Voltage	$-V_{DS}$	30	V
Gate-Source Voltage	$-V_{GS}$	$\pm 20$	V
Drain Current-Continuous	$-I_D$	40	A
Drain Current-Pulsed <sup>Note1</sup>	$-I_{DM}$	120	A
Maximum Power Dissipation	$P_D$	58	W
Single Pulse Avalanche Energy <sup>Note2</sup>	$E_{AS}$	105	mJ
Junction Temperature	$T_J$	150	°C
Storage Temperature Range	$T_{STG}$	-55 to +150	°C

### Thermal Characteristics

Thermal Resistance, Junction-to-Case	$R_{\theta JC}$	2.2	°C/W
--------------------------------------	-----------------	-----	------



# PJM40P30TE

## P-Channel Enhancement Mode Power MOSFET

### Electrical Characteristics

( $T_J=25^{\circ}\text{C}$  unless otherwise specified)

Parameter	Symbol	Test Condition	Min.	Typ.	Max.	Unit
<b>Static Characteristics</b>						
Drain-Source Breakdown Voltage	$-V_{(BR)DSS}$	$V_{GS}=0V, I_D=-250\mu A$	30	--	--	V
Zero Gate Voltage Drain Current	$-I_{DSS}$	$V_{DS}=-30V, V_{GS}=0V$	--	--	1	$\mu A$
Gate-Body Leakage Current	$I_{GSS}$	$V_{GS}=\pm 20V, V_{DS}=0V$	--	--	$\pm 100$	nA
Gate Threshold Voltage <sup>Note3</sup>	$-V_{GS(th)}$	$V_{DS}=V_{GS}, I_D=-250\mu A$	1	1.7	2.5	V
Drain-Source On-Resistance <sup>Note3</sup>	$R_{DS(on)}$	$V_{GS}=-10V, I_D=-20A$	--	7	9.5	m $\Omega$
		$V_{GS}=-4.5V, I_D=-10A$	--	12.5	18	m $\Omega$
Forward Transconductance <sup>Note3</sup>	$g_{FS}$	$V_{DS}=-5V, I_D=-1A$	--	6.5	--	S
<b>Dynamic Characteristics</b>						
Input Capacitance	$C_{iss}$	$V_{DS}=-15V, V_{GS}=0V, f=1\text{MHz}$	--	1810	--	pF
Output Capacitance	$C_{oss}$		--	315	--	pF
Reverse Transfer Capacitance	$C_{rss}$		--	265	--	pF
Gate Resistance	$R_g$	$V_{DS}=0V, V_{GS}=0V, f=1\text{MHz}$	--	17	--	$\Omega$
Total Gate Charge	$Q_g$	$V_{DS}=-15V, I_D=-5A,$ $V_{GS}=-10V$	--	40	--	nC
Gate-Source Charge	$Q_{gs}$		--	7	--	nC
Gate-Drain Charge	$Q_{gd}$		--	8	--	nC
<b>Switching Characteristics</b>						
Turn-on Delay Time	$t_{d(on)}$	$V_{DD}=-15V, I_D=-10A,$ $V_{GS}=-10V, R_{GEN}=2.4\Omega$	--	10	--	nS
Turn-on Rise Time	$t_r$		--	60	--	nS
Turn-off Delay Time	$t_{d(off)}$		--	52	--	nS
Turn-off Fall Time	$t_f$		--	72	--	nS
<b>Source-Drain Diode Characteristics</b>						
Diode Forward Voltage	$-V_{SD}$	$V_{GS}=0V, I_S=-30A$	--	--	1.2	V
Diode Forward Current	$-I_S$		--	--	40	A

Note: 1. Repetitive Rating: Pulse width limited by maximum junction temperature

2. EAS condition:  $T_J=25^{\circ}\text{C}, V_{DD}=-15V, V_G=-10V, R_G=25\Omega, L=0.5\text{mH}, I_{AS}=-20.5A$

3. Pulse Test: Pulse Width $\leq 300\mu\text{s}$ , Duty Cycle $\leq 0.5\%$



# PJM40P30TE

## P-Channel Enhancement Mode Power MOSFET

### Typical Characteristic Curves

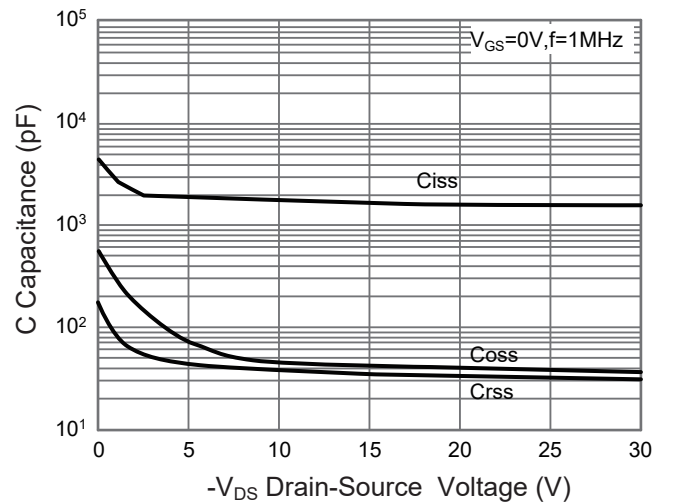
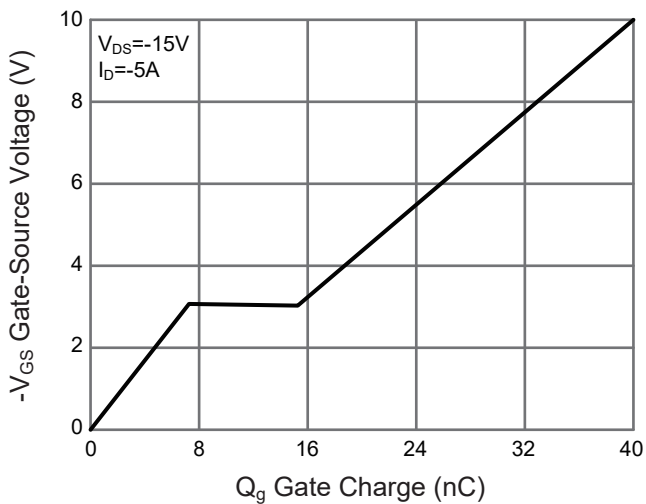
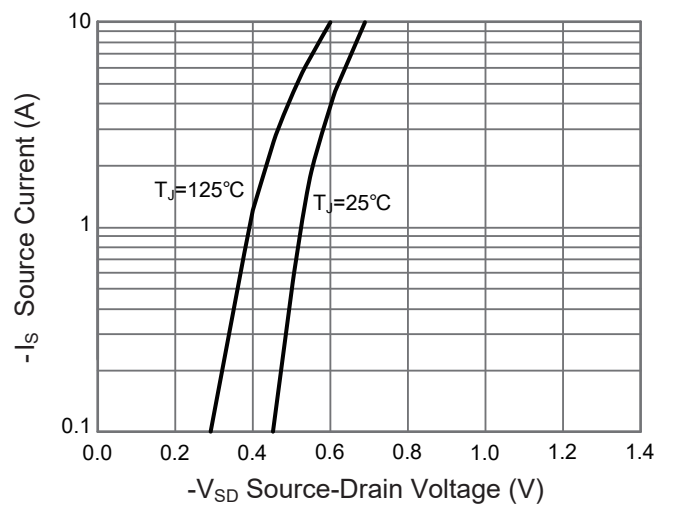
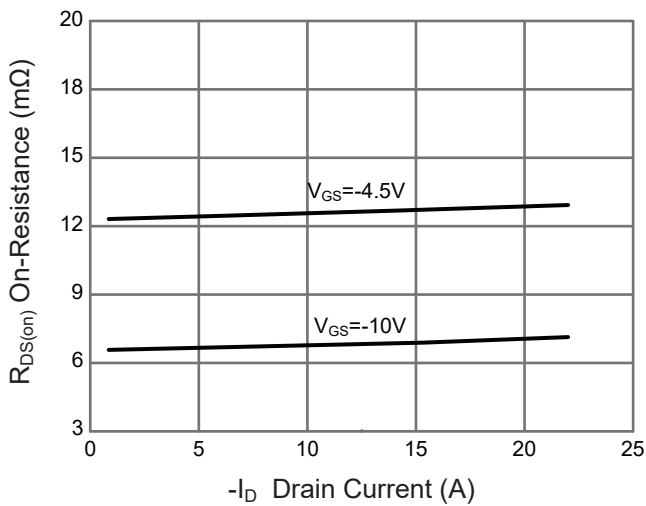
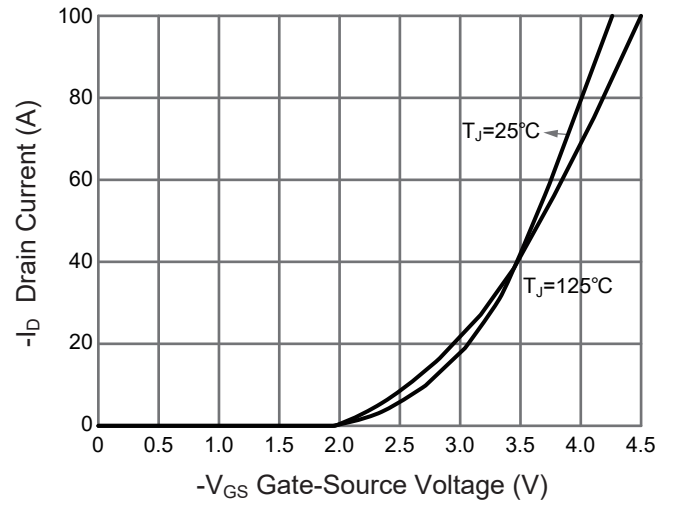
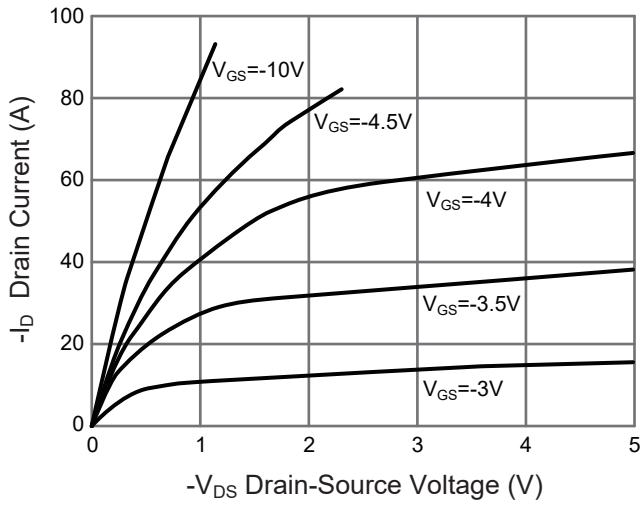



# PJM40P30TE

## P-Channel Enhancement Mode Power MOSFET

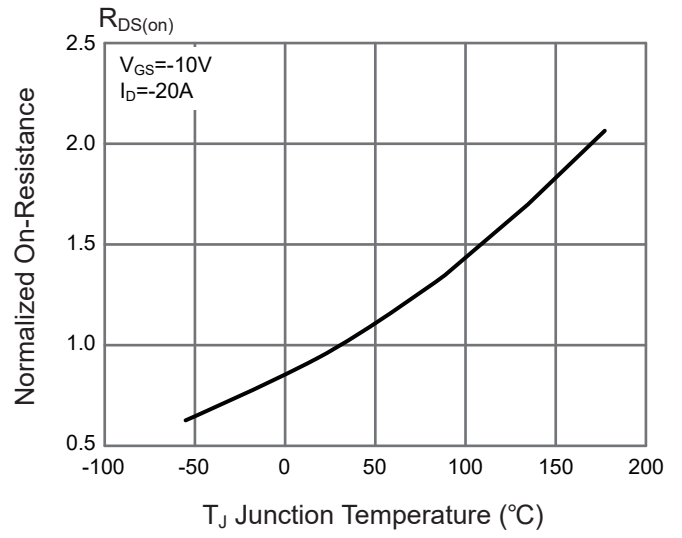
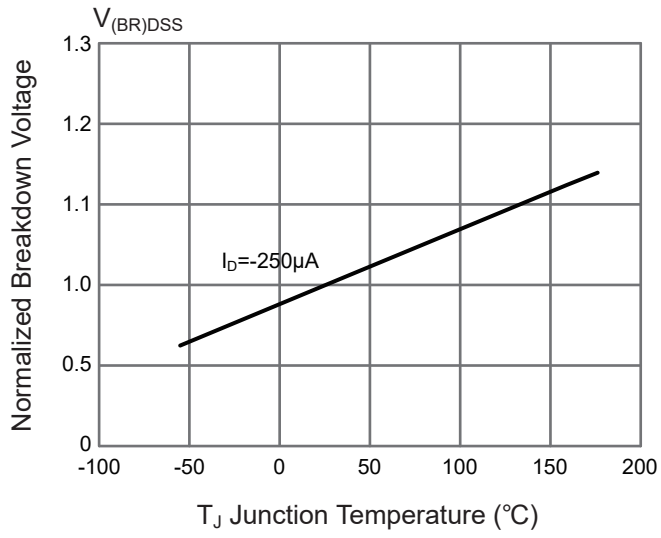

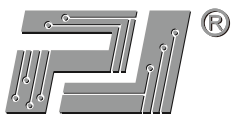

# PJM40P30TE

## P-Channel Enhancement Mode Power MOSFET

### Package Outline

TO-252

Dimensions in mm

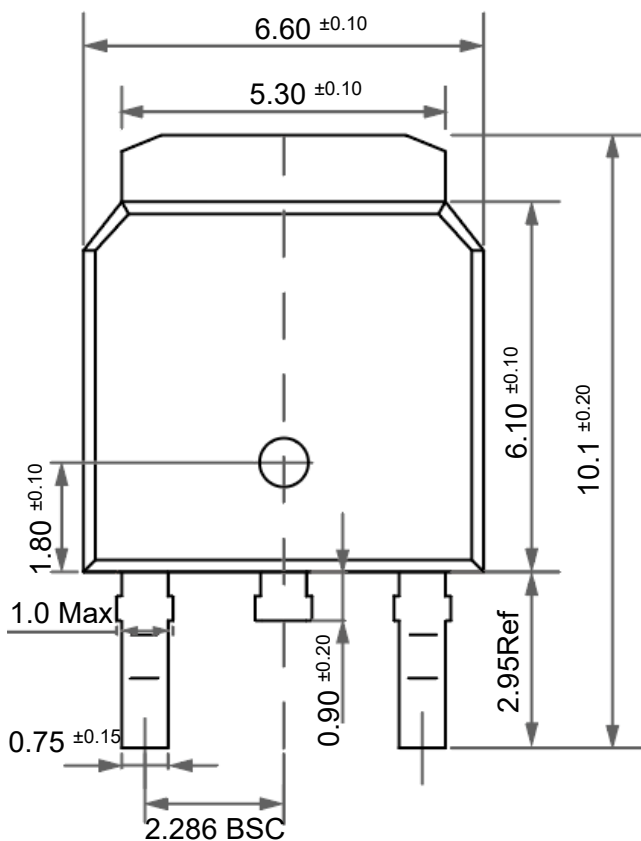

**Front View**

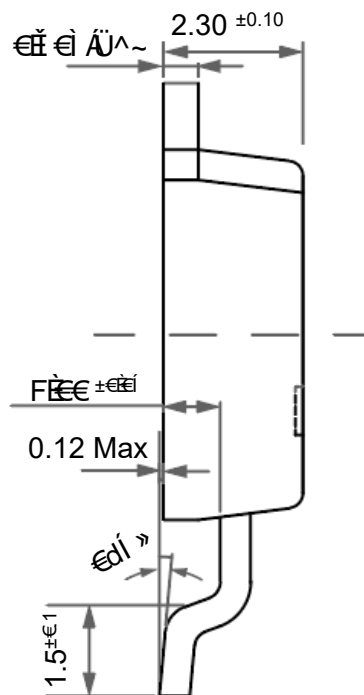

**Side View**

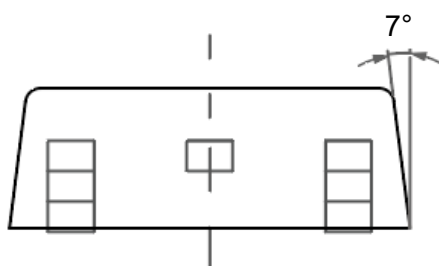

**Bottom View**

### Ordering Information

Device	Package	Shipping
PJM40P30TE	TO-252	2,500PCS/Reel&13inches



### Conditions of Soldering and Storage

#### ◆ Recommended condition of reflow soldering

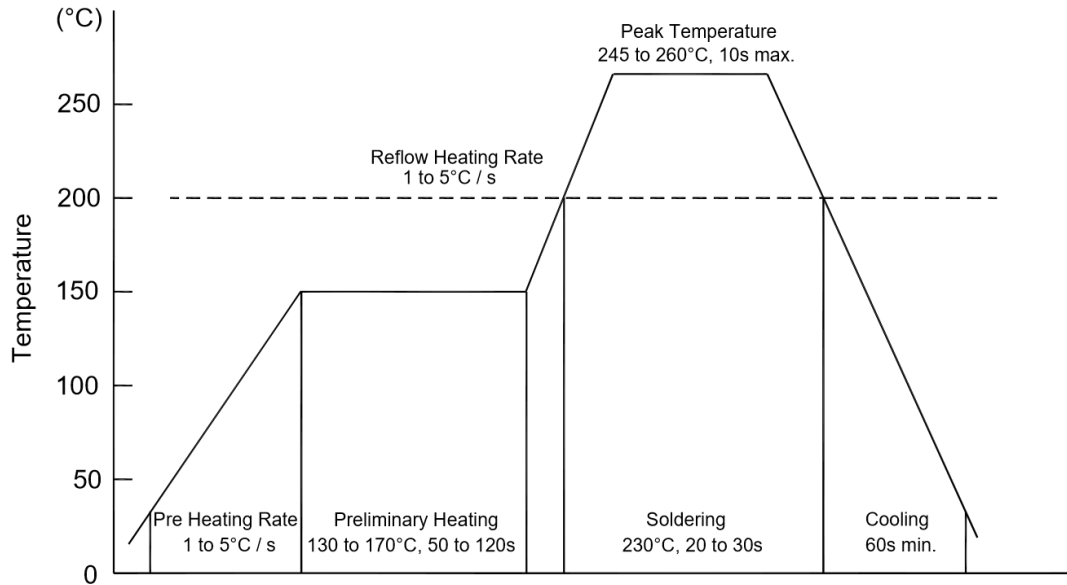

Recommended peak temperature is over 245°C. If peak temperature is below 245°C, you may adjust the following parameters:

- Time length of peak temperature (longer)
- Time length of soldering (longer)
- Thickness of solder paste (thicker)

#### ◆ Conditions of hand soldering

- Temperature: 300°C
- Time: 3s max.
- Times: one time

#### ◆ Storage conditions

- **Temperature**  
5 to 40°C
- **Humidity**  
30 to 80% RH
- **Recommended period**  
One year after manufacturing

### Package Specifications

- The method of packaging

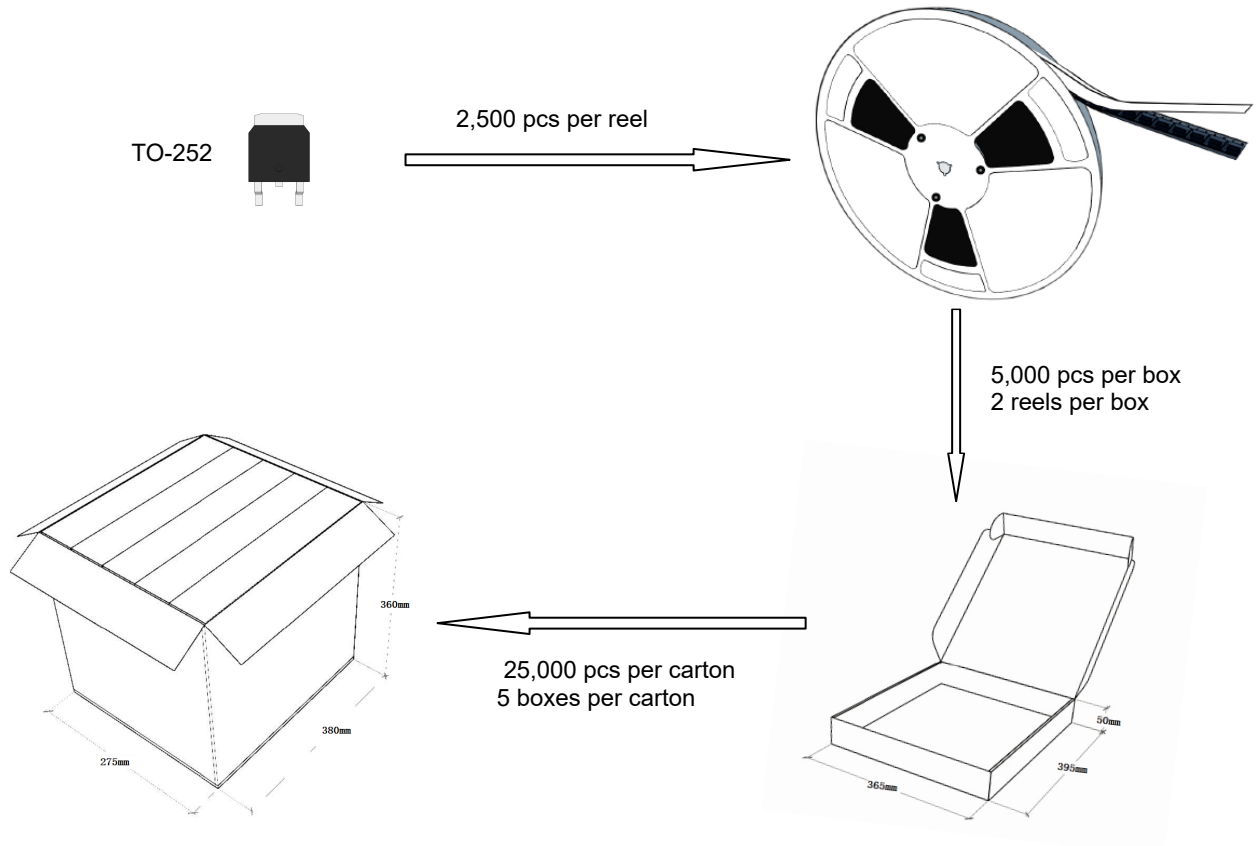

### reel data

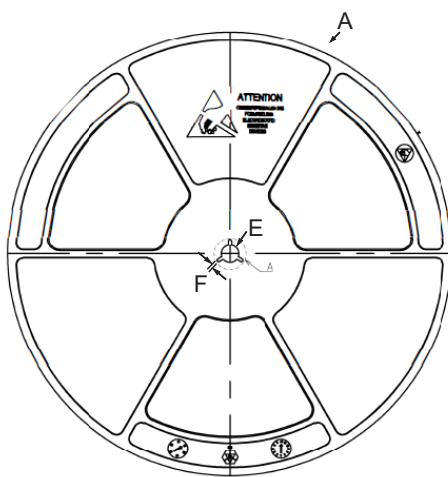

Symbol	Value(unit:mm)
A	$\Phi 330.2 \pm 1$
B	$17 \pm 0.5$
C	$21.2 \pm 2$
D	$\Phi 100 \pm 0.5$
E	$\Phi 13.4 \pm 0.2$
F	$2.3 \pm 0.2$
T	$2.1 \pm 0.2$



# PJM40P30TE

## P-Channel Enhancement Mode Power MOSFET

### ◆ Embossed tape data

