



RS1AF-PJ~RS1MF-PJ

Surface Mount Fast Recovery Rectifiers

Features

- For surface mount applications
- Glass passivated chip junction
- Fast reverse recovery time

SMAF

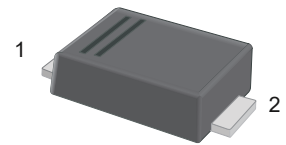

1.Cathode  2.Anode

Marking Code:

RS1AF-PJ: RS1A
 RS1BF-PJ: RS1B
 RS1DF-PJ: RS1D
 RS1GF-PJ: RS1G
 RS1JF-PJ: RS1J
 RS1KF-PJ: RS1K
 RS1MF-PJ: RS1M

Maximum Ratings and Electrical Characteristics

Ratings at 25°C ambient temperature unless otherwise specified. Single phase half-wave 60 Hz, resistive or inductive load, for capacitive load current derate by 20 %.

Parameter	Symbols	RS1AF-PJ	RS1BF-PJ	RS1DF-PJ	RS1GF-PJ	RS1JF-PJ	RS1KF-PJ	RS1MF-PJ	Units
Maximum Repetitive Peak Reverse Voltage	V_{RRM}	50	100	200	400	600	800	1000	V
Maximum RMS Voltage	V_{RMS}	35	70	140	280	420	560	700	V
Maximum DC Blocking Voltage	V_{DC}	50	100	200	400	600	800	1000	V
Maximum Average Forward Rectified Current at $T_C = 125^\circ\text{C}$	$I_{F(AV)}$	1.0							A
Peak Forward Surge Current 8.3 ms Single Half Sine Wave Superimposed on Rated Load	I_{FSM}	30							A
Maximum Instantaneous Forward Voltage at 1 A	V_F	1.3							V
Maximum DC Reverse Current at Rated DC Blocking Voltage $T_A = 25^\circ\text{C}$ $T_A = 125^\circ\text{C}$	I_R	5 50							μA
Typical Junction Capacitance ^{Note1}	C_j	15							pF
Typical Thermal Resistance ^{Note2}	$R_{\theta JA}$	80							$^\circ\text{C/W}$
Maximum Reverse Recovery Time ^{Note3}	T_{rr}	150				250	500		nS
Junction Temperature	T_J	150							$^\circ\text{C}$
Storage Temperature Range	T_{STG}	-55 to +150							$^\circ\text{C}$

Note:

1. Measured at 1 MHz and applied reverse voltage of 4 V D.C
2. P.C.B. mounted with 2.0" X 2.0" (5 X 5 cm) copper pad areas.
3. Measured with $I_F = 0.5\text{ A}$, $I_R = 1\text{ A}$, $I_{rr} = 0.25\text{ A}$



RS1AF-PJ~RS1MF-PJ

Surface Mount Fast Recovery Rectifiers

Typical Characteristic Curves

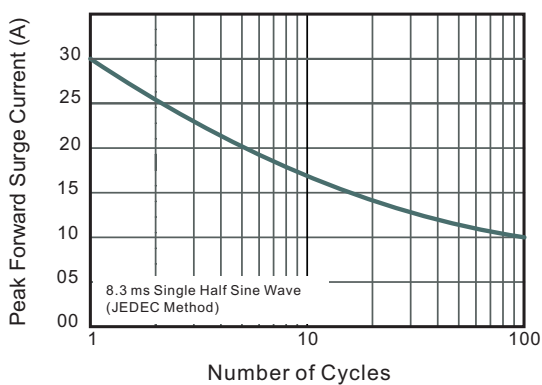
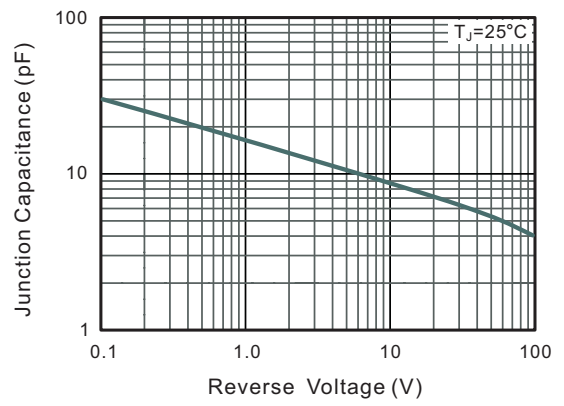
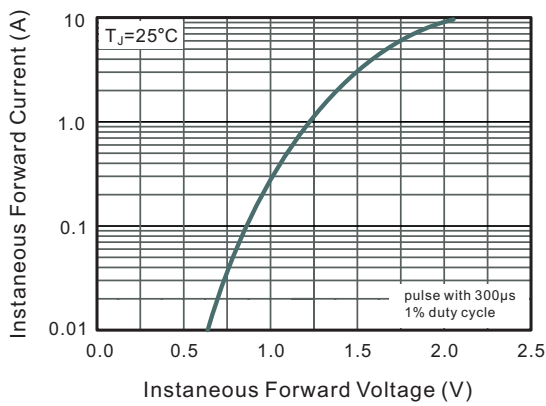
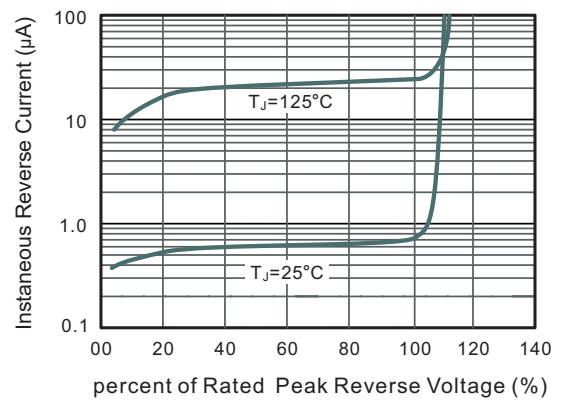
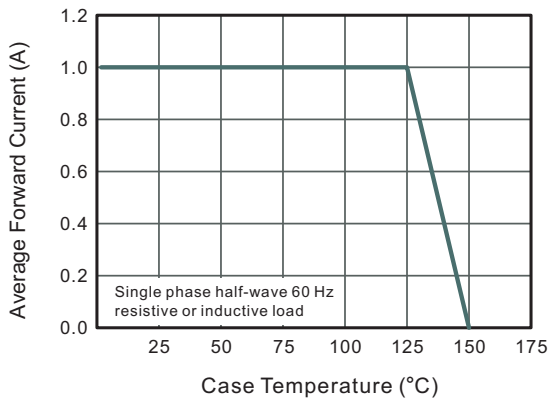



RS1AF-PJ~RS1MF-PJ

Surface Mount Fast Recovery Rectifiers

Package Outline

SMAF

Dimensions in mm

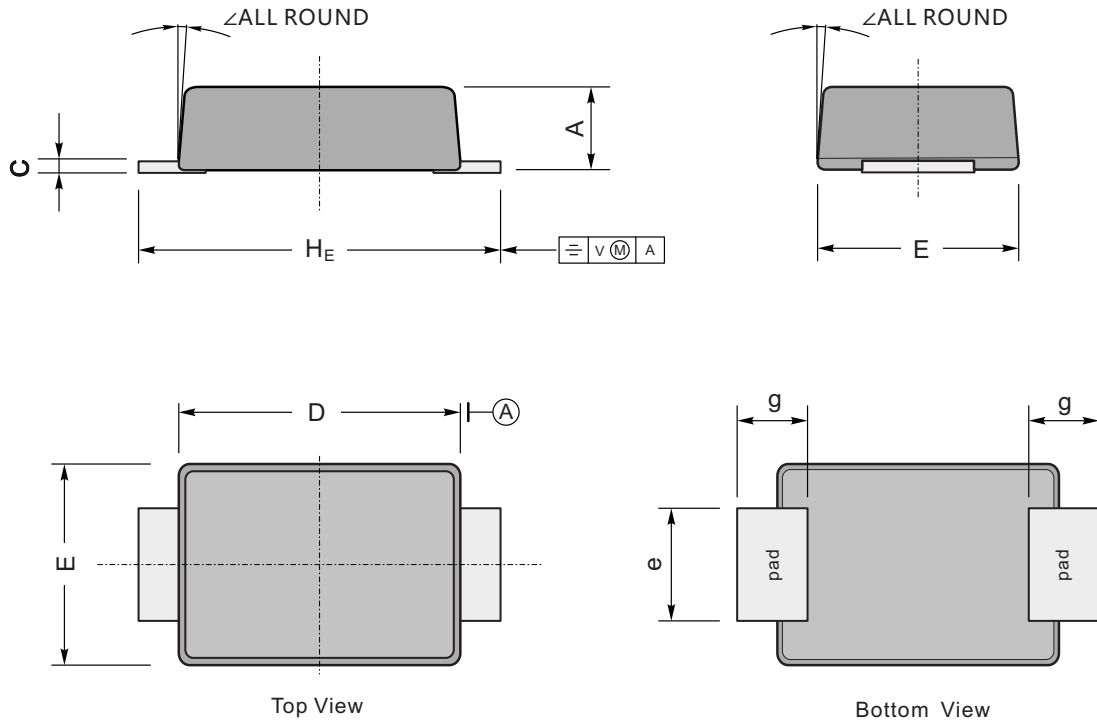

UNIT		A	C	D	E	e	g	H _E	∠
mm	max	1.2	0.20	3.7	2.7	1.6	1.2	4.9	7°
	min	0.9	0.12	3.3	2.4	1.3	0.8	4.4	
mil	max	47	7.9	146	106	63	47	193	
	min	35	4.7	130	94	51	31	173	