



# RS5AB-PJ~RS5MB-PJ

## Surface Mount Fast Recovery Rectifiers

### Features

- For surface mounted applications
- Glass Passivated Chip Junction
- Fast reverse recovery time
- Low profile package

### SMB

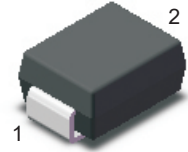

1.Cathode  2.Anode

### Marking Code:

RS5AB-PJ: RS5A  
 RS5AB-PJ: RS5B  
 RS5AB-PJ: RS5D  
 RS5AB-PJ: RS5G  
 RS5AB-PJ: RS5J  
 RS5AB-PJ: RS5K  
 RS5AB-PJ: RS5M

### Maximum Ratings and Electrical Characteristics

Ratings at 25°C ambient temperature unless otherwise specified. Single phase half-wave 60 Hz, resistive or inductive load, for capacitive load current derate by 20 %.

Parameter	Symbols	RS5AB-PJ	RS5BB-PJ	RS5DB-PJ	RS5GB-JP	RS5JB-PJ	RS5KB-PJ	RS5MB-PJ	Units
Maximum Repetitive Peak Reverse Voltage	$V_{RRM}$	50	100	200	400	600	800	1000	V
Maximum RMS Voltage	$V_{RMS}$	35	70	140	280	420	560	700	V
Maximum DC Blocking Voltage	$V_{DC}$	50	100	200	400	600	800	1000	V
Maximum Average Forward Rectified Current	$I_{F(AV)}$	5.0							A
Peak Forward Surge Current 8.3 ms Single Half Sine Wave Superimposed on Rated Load	$I_{FSM}$	120							A
Maximum Instantaneous Forward Voltage at 5 A	$V_F$	1.3							V
Maximum DC Reverse Current at Rated DC Blocking Voltage $T_A = 25\text{ }^\circ\text{C}$ $T_A = 125\text{ }^\circ\text{C}$	$I_R$	10 150							$\mu\text{A}$
Typical Junction Capacitance <sup>Note1</sup>	$C_j$	45							pF
Typical Thermal Resistance <sup>Note2</sup>	$R_{\theta JA}$ $R_{\theta JC}$	48 16							$^\circ\text{C/W}$
Maximum Reverse Recovery Time <sup>Note3</sup>	$T_{rr}$	150				250	500		nS
Junction Temperature	$T_J$	150							$^\circ\text{C}$
Storage Temperature Range	$T_{STG}$	-55 to +150							$^\circ\text{C}$

### Note:

1. Measured at 1 MHz and applied reverse voltage of 4 V D.C
2. P.C.B. mounted with 2.0" X 2.0" (5 X 5 cm) copper pad areas.
3. Measured with  $I_F = 0.5\text{ A}$ ,  $I_R = 1\text{ A}$ ,  $I_{rr} = 0.25\text{ A}$



# RS5AB-PJ~RS5MB-PJ

## Surface Mount Fast Recovery Rectifiers

### Typical Characteristic Curves

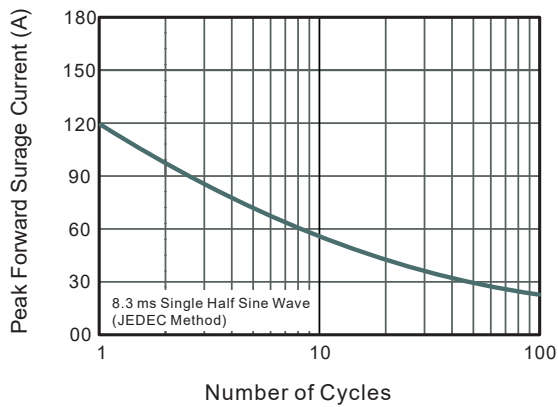
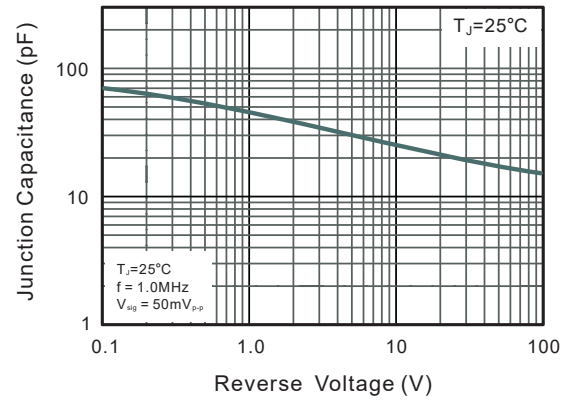
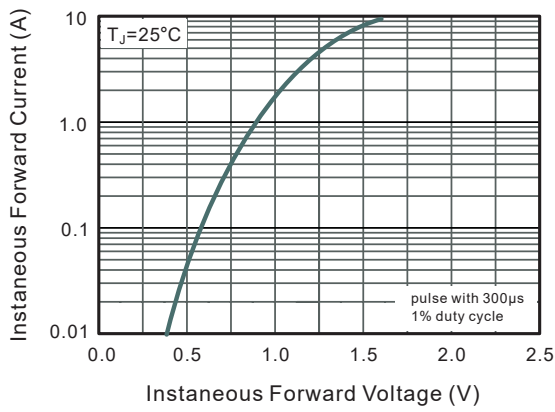
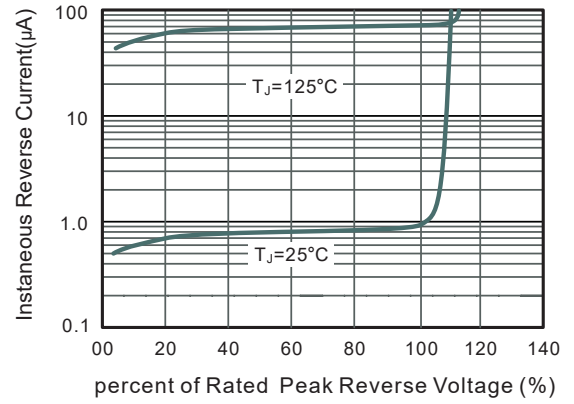
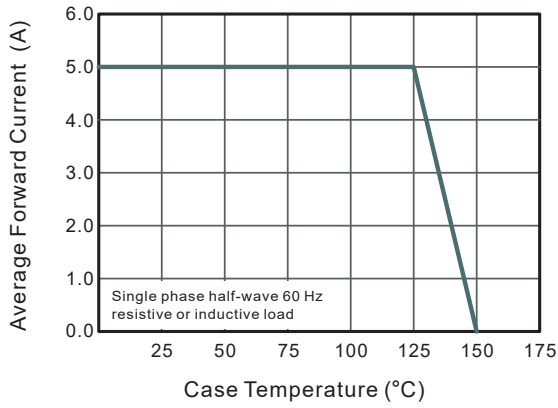



# RS5AB-PJ~RS5MB-PJ

## Surface Mount Fast Recovery Rectifiers

### Package Outline

SMB

Dimensions in mm

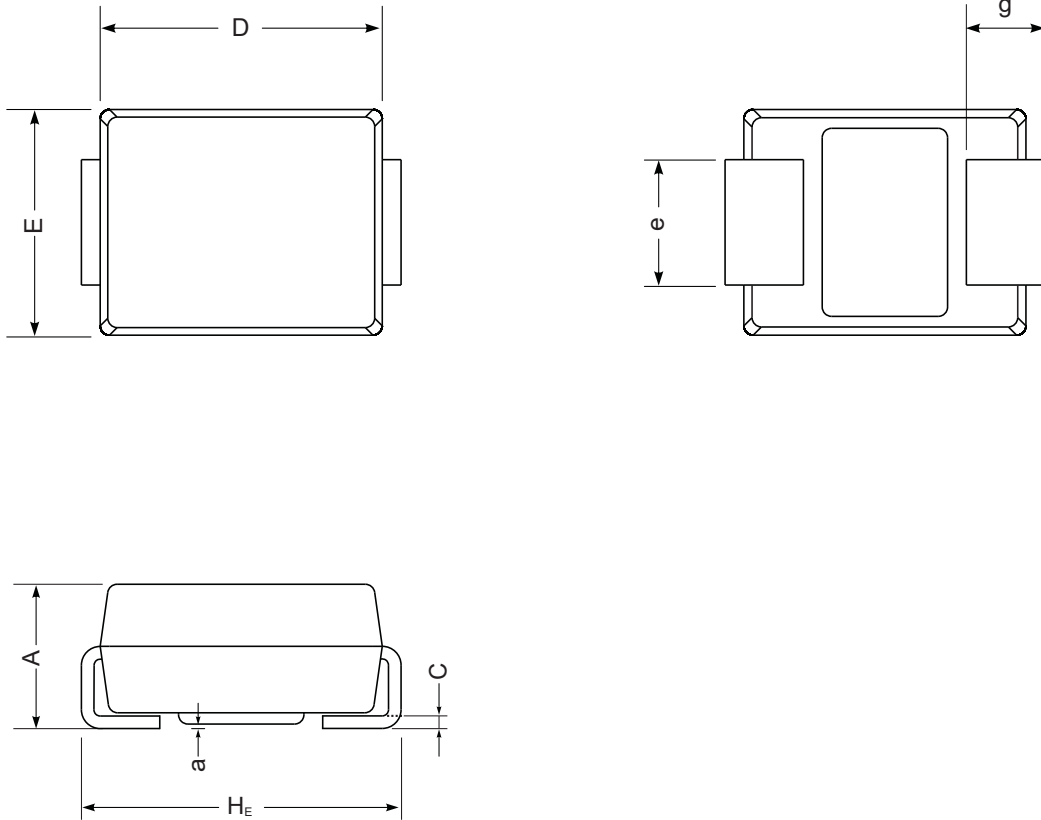

UNIT		A	E	D	E1	A1	L	C	b
mm	max	2.44	4.70	3.94	5.59	0.20	1.5	0.305	2.2
	min	2.13	4.06	3.3	5.08	0.05	0.8	0.152	1.9
mil	max	96	185	155	220	7.9	59	12	87
	min	84	160	130	200	2.0	32	6	75