

### Features

- Low power loss, high efficiency
- For surface mounted applications
- High forward surge current capability

### SMAF

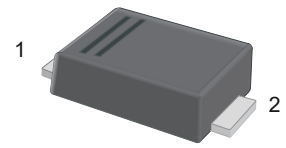

1.Cathode  2.Anode

Marking Code :SSL34

### Absolute Maximum Ratings and Electrical Characteristics

Ratings at 25°C ambient temperature unless otherwise specified.

Parameter	Symbols	SSL34F-PJ	Units
Maximum Repetitive Peak Reverse Voltage	$V_{RRM}$	40	V
Maximum RMS Voltage	$V_{RMS}$	28	V
Maximum DC Blocking Voltage	$V_{DC}$	40	V
Maximum Average Forward Rectified Current $T_C = 100^\circ\text{C}$	$I_{F(AV)}$	3	A
Peak Forward Surge Current 8.3 ms Single Half Sine Wave Superimposed on Rated Load	$I_{FSM}$	80	A
Maximum Instantaneous Forward Voltage at 3 A	$V_F$	0.45	V
Maximum DC Reverse Current at Rated DC Blocking Voltage	$I_R$	$T_A = 25^\circ\text{C}$ 0.3	mA
		$T_A = 100^\circ\text{C}$ 5	
Typical Junction Capacitance <sup>Note1</sup>	$C_J$	450	pF
Typical Thermal Resistance <sup>Note2</sup>	$R_{\theta JA}$	60	$^\circ\text{C}/\text{W}$
	$R_{\theta JC}$	18	
Junction Temperature	$T_J$	150	$^\circ\text{C}$
Storage Temperature Range	$T_{STG}$	-55 to +150	$^\circ\text{C}$

#### Note:

1. Measured at 1 MHz and applied reverse voltage of 4 V D.C
2. P.C.B. mounted with 2.0" X 2.0" (5 X 5 cm) copper pad areas.



### Typical Characteristic Curves

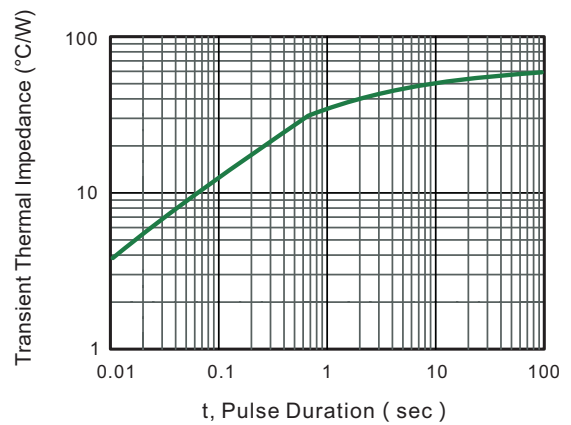
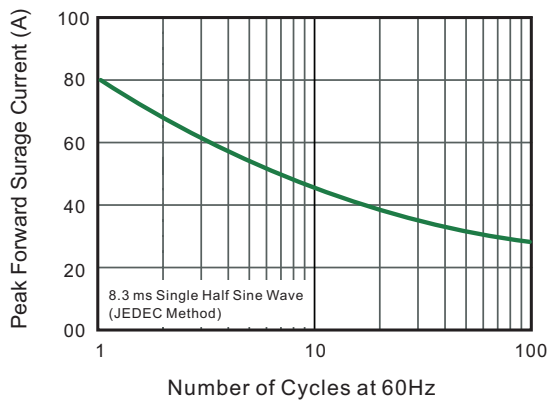
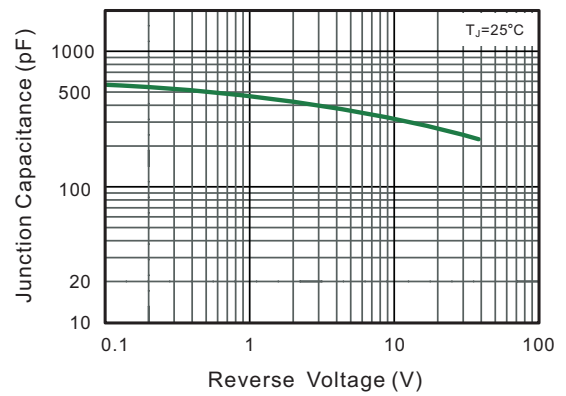
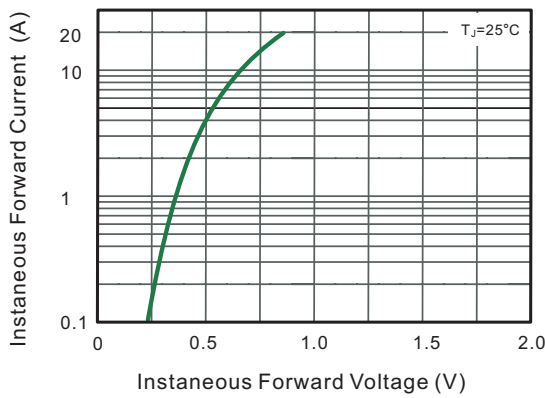
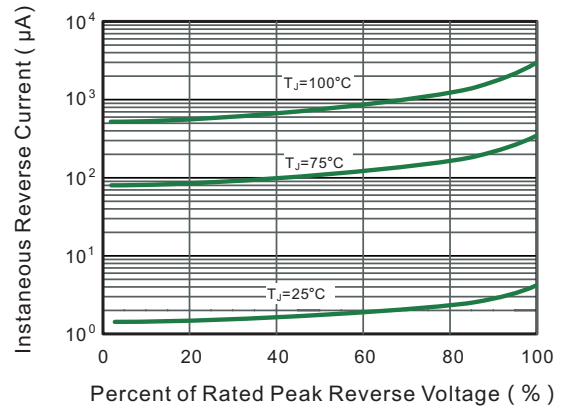
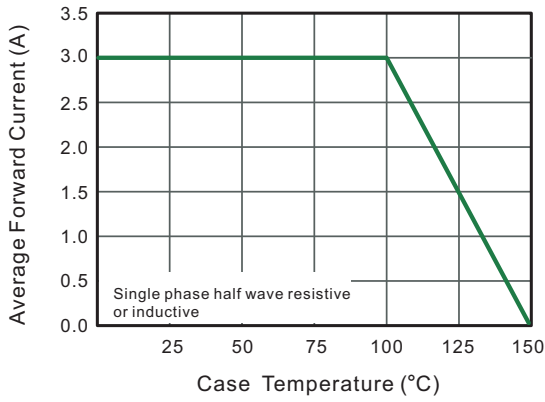

### Package Outline

SMAF

Dimensions in mm

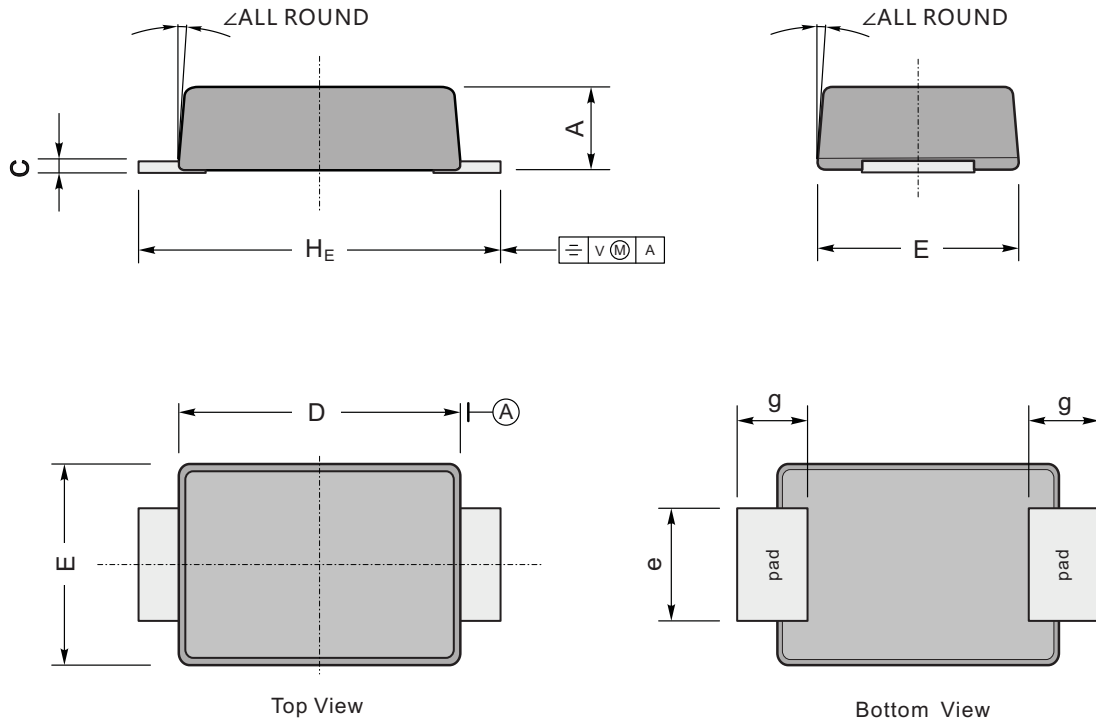

UNIT		A	C	D	E	e	g	$H_E$	$\angle$
mm	max	1.2	0.20	3.7	2.7	1.6	1.2	4.9	7°
	min	0.9	0.12	3.3	2.4	1.3	0.8	4.4	
mil	max	47	7.9	146	106	63	47	193	
	min	35	4.7	130	94	51	31	173	